

lifting chains & components



INTRODUCTION

Cookes' has over 100 years of experience in lifting equipment and is proud to offer you New Zealand's finest lifting chains and components. Chain slings can be fabricated to your specific requirements, then tagged and supported by the necessary certification. With in-house and mobile testing facilities throughout New Zealand, we can ensure that your lifting chains remain safe for continued use.

LIFTING CHAIN & COMPONENTS

Which grade do I choose?

Grade 80

Has been the choice of many users for over 40 years and offers the widest range of matching strength component items.

Standard features include:

- Wide range of available sizes and components
- High strength to weight ratio
- Safe for overhead lifting and general purpose lifting slings

Cookes is the authorised New Zealand distributor for Grade 80 components manufacturer Yoke Industrial, and offer Grade 80 alloy lifting chain from both Peerless Industrial USA and PWB Anchor, Australia.

Grade 100

Developed in Europe in the late 1990s, and standard features include:

- Approximately 25% higher Working Load Limit (WLL) than Grade 80
- Wide range of available sizes
- Higher strength to weight ratio than Grade 80
- Safe for overhead lifting and general purpose lifting slings

Cookes is the authorised New Zealand distributor for Grade 100 components manufacturers Yoke Industrial and the Crosby Group (Kuplex). We offer Grade 100 alloy lifting chain from both Peerless Industrial USA and Crosby Group USA.

Grade 120

Developed in Europe in the mid-2000s, the German manufactured Rud ICE-120 chain and components offer several unique features:

- 50% higher Working Load Limit (WLL) than Grade 80 lifting chains of the same diameter
- ICE-120 chain and components dynamically loaded to 20,000 cycles at 1.5 times WLL
- Double the impact toughness of Grade

80 chain to EN 818

- 30% better surface hardness than Grade 80
- Duplex surface protection provides superior protection against corrosion
- Improved resistance to stress corrosion cracking and hydrogen embrittlement
- Significantly increased life expectancy due to superior alloys and special heat treatment
- Patented material provides increased resistance to sharp edges
- Higher elongation than Grade 80 chain
- Unique range of purpose-designed components
- Safe for overhead lifting and special purpose lifting slings

Cookes is the authorised New Zealand distributor for German manufacturer Rud and offers the ICE-120 range in sizes 4mm through 16mm.

VIP Maxi-Heavy Lift

A range of 28mm chain and special components from Rud Germany designed specifically for heavy lift applications featuring:

- Sling Working Load Limits up to 126 tonne
- Special top link design with integrated chain connection
- Edge wear resistance
- Powder coated finish

Grade 50 Stainless Steel

A range of chain and components manufactured in France and certified for overhead lifting featuring:

- A range of chain and components in sizes from 6mm to 13mm
- Highly resistant to corrosion in acid and alkaline environments
- Suitable for use in salt water and marine environments
- Recommended for food processing and chemical plants
- Safe for overhead lifting and special purpose lifting slings

OUR
WORLD LEADING
PARTNERS...



COOKES – helping lift New Zealand business for over 100 years!
a BRIDON · BEKAERT Popes Group Brand

CHAIN SLING WORKING LOAD LIMITS

The Uniform Method for Rating GRADE 80 Chain Slings

Lifting Mode	1 Leg	2 Leg			3 & 4 Leg – Same Ratings		
Chain Ø	Factor 1	Factor 1.7	Factor 1.4	Factor 1	Factor 2.6	Factor 2.1	Factor 1.5
mm	0°	60°	90°	120°	60°	90°	120°
6.00	1.12	1.90	1.60	1.12	2.90	2.36	1.70
7.00	1.50	2.55	2.12	1.50	3.90	3.15	2.24
8.00	2.00	3.40	2.80	2.00	5.20	4.25	3.00
10.00	3.15	5.35	4.25	3.15	8.20	6.70	4.75
13.00	5.30	9.00	7.50	5.30	13.80	11.20	8.00
16.00	8.00	13.60	11.20	8.00	20.80	17.00	11.80
19.00	11.20	19.00	16.00	11.20	29.00	23.60	17.00
20.00	12.50	21.25	17.00	12.50	32.50	26.50	19.00
22.00	15.00	25.50	21.20	15.00	39.00	31.50	22.40
26.00	21.20	36.00	30.00	21.20	55.10	45.00	31.50
32.00	31.50	53.50	45.00	31.50	81.90	67.00	47.50

WORKING LOAD LIMITS (TONNES) IN ACCORDANCE WITH STANDARD EN818-4

The Working Load Limits (WLL) listed in the table above are the maximum weights which slings are designed to sustain in general lifting service according to the standard Uniform Load Method of rating. General purpose chain slings must always be rated by the Uniform Method. Under this method, four-leg chain slings have the same WLL rating as three-leg slings based on an assumption that at least one leg of a four-leg sling may not be accepting its full share of the load.

In exceptionally hazardous conditions or in any other circumstances which might indicate a need for the Working Load Limit lower than the designated figure, the degree of hazard should be assessed by a competent person and a Safe Working Load (SWL) determined.

RATING SPECIAL PURPOSE CHAIN SLINGS BY THE TRIGONOMETRIC METHOD

The alternative Trigonometric Method may only be used where a multi-leg sling is to be used for a specific lifting application, with the angle between the legs pre-determined and constant. In such cases the WLL can be calculated on the basis of the specific angle specified and the chain sling will be tagged accordingly.



• For further information on trigonometric rating of chain slings, please contact your local Cookes branch, Freephone 0508 274 366 or email customerservices@bridoncookes.co.nz.



• When slings are used in a choke hitch or grab hooks fitted as bottom hooks, the WLL must be reduced by 20%.
• For G100 chain sling ratings refer to page 41.



• Never exceed manufacturer's Working Load Limit (WLL).
• Never use a chain assembly for lifting unless it has been tagged and certified by a reputable supplier.
• Never exceed 120° included sling angle between legs.

GRADE 80

LIFTING CHAIN

Kito Grade 80 Alloy Chain



Product Code	Nominal Size	WLL	Inside Link Dimensions (mm)		Approx. Weight
	mm	t	Length (Nom.)	Width (Min.)	kg / mtr
02399006	6	1.2	18	7.80	0.83
02399007	7	1.5	21	9.10	1.17
02399008	8	2.0	24	10.40	1.51
02399010	10	3.15	30	13.00	2.40
02399013	13	5.3	39	16.90	4.00
02399016	16	8.0	48	20.80	6.00
02399020	20	12.5	60	26.00	9.21
02398822	22	15.0	67	32.00	10.40
02398826	26	21.2	78	35.50	15.50



A rugged high strength Ni-Cr-Mo Alloy Steel chain.

- Complies with EN818.
- Sizes 6mm - 20mm manufactured by Kito Weissenfels, Italy.
- Sizes 22mm and 26mm manufactured by Kito Peerless, USA.

Herc-Alloy Grade 80 Alloy Chain



Product Code	Size (mm)	WLL	Dimensions (mm)		Approx. Weight
	S	t	R	F	kg / mtr
02950010	7.1	1.6	23.8	25.9	1.14
02950012	8.0	2.0	23.8	27.0	1.40
02950014	10.0	3.2	29.8	33.8	2.10
02950018	13.0	5.3	38.0	43.0	3.49
02950022	16.0	8.0	47.8	54.0	5.64
02950026	20.0	12.5	59.2	67.5	8.78
02950030	22.0	15.0	65.0	74.2	10.70
02950034	26.0	20.2	78.0	96.2	15.10
02950040	32.0	31.5	96.0	112.0	23.00

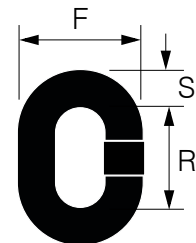

Proven performance in high impact applications.

- Self-colour finish.
- Complies with AS2321.
- Sizes 6mm - 22mm manufactured in Australia.
- Sizes 26mm - 32mm manufactured in Germany.



• Never exceed manufacturer's Working Load Limit (WLL).

GRADE 80

MASTER LINKS & MULTI OBLONG LINKS

Highest quality master links from world leading manufacturers.



MASTER LINKS – 1 & 2 LEG SLINGS

Oblong Master Link – Type MF

YOKE

Product Code	Yoke Item No.	WLL β 0-45°	For G80 Chain (mm)		Dimensions (mm)			Weight kg
		t	1 Leg	2 Leg	D	IL	IW	
02457006	8-003-06	1.12	6	—	11	100	60	0.2
02457008	8-003-0806	2.36	7, 8	6	14	120	70	0.4
02457010	8-003-1008	4.25	10	7, 8	17	140	80	0.7
02457013	8-003-1310	6.70	13	10	22	160	95	1.5
02457016	8-003-1613	11.20	16	13	28	180	105	2.8
02457022	8-003-2216	17.00	20, 22	16	34	240	140	5.5
02457026	8-003-2619	26.50	26	19, 20	40	250	150	8.0
02457032	8-003-3222	31.50	32	22	45	300	180	12.7

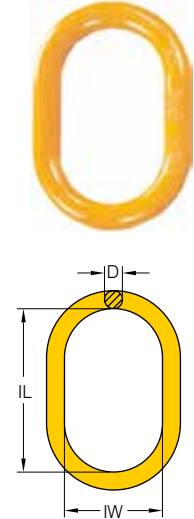

- Designed for use in 1 and 2 leg sling applications.
- Design factor 4:1 proof tested and certified.
- Complies with EN1677.
- Manufactured in Taiwan.

Oblong Master Link With Flat – Type MFF

YOKE

Product Code	Yoke Item No.	WLL β 0-45°	For G80 Chain (mm)		Dimensions (mm)			Weight kg
		t	1 Leg	2 Leg	D	IL	IW	
02456007	8-003F-0806	2.36	7, 8	6	14	120	70	0.4
02456010	8-003F-1008	4.25	10	7, 8	17	141	80	0.7
02456013	8-003F-1310	6.70	13	10	23	163	95	1.5
02456016	8-003F-1613	11.20	16	13	29	180	105	2.8
02456019	8-003F-2216	17.00	20, 22	16	34	245	140	5.3
02456026	8-003F-2619	26.50	26	19, 20	40	257	150	8.0

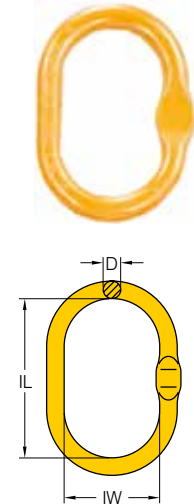

- Designed for use in 1 and 2 leg sling applications.
- Flat section enables chain connection using Omega Link, Kupler or Unilock Shackle.
- Design factor 4:1 proof tested and certified.
- Complies with EN1677
- Manufactured in Taiwan.



• Never exceed manufacturer's Working Load Limit (WLL).

MASTER LINKS – 1 & 2 LEG SLINGS

Herc-Alloy Welded Oblong Link – Regular



Product Code	PWB Item No.	WLL	Chain Size (mm)		Dimensions (mm)			Weight
		t	1 Leg	2 Leg	H	J	K	kg
02951050*	40490	3.5	6.0 – 10.0	6.0 – 8.0	88	44	13	0.3
02951058*	40491	5.5	13.0	10.0	114	57	20	0.9
02951062*	40492	9.2	16.0	13.0	130	70	22	1.2
02951070	40493	13.8	20.0	16.0	160	80	30	2.7
02951072	40494	21.6	22.0	20.0	180	90	32	3.7
02951073	40495	26.0	26.0	22.0	200	100	40	5.5

* Available on indent.

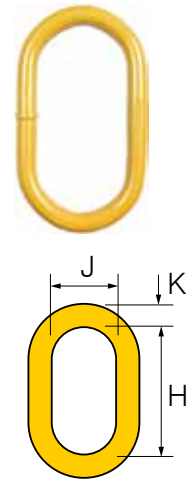

Herc-Alloy Welded Oblong Link – Large



Product Code	PWB Item No.	WLL	Chain Size (mm)		Dimensions (mm)			Weight
		t	1 Leg	2 Leg	H	J	K	kg
02951140*	40617	1.6	6.0 – 7.1	—	130	70	13	0.4
02951145*	40618	3.5	8.0 – 10.0	7.1 – 8.0	135	70	16	0.7
02951147*	40619	5.5	13.0	10.0	200	100	22	1.7
02951152*	40620	9.2	16.0	13.0	240	120	30	3.8
02951155*	40621	13.8	20.0	16.0	280	140	32	5.4
02951156	40622	21.6	22.0	20.0	300	150	40	8.5
02951157	40623	26.0	26.0	22.0	330	165	42	10.5
02951158	40624	36.7	32.0	26.0	360	180	50	15.0
02951159*	41767	54.5	32.0	32.0	410	220	60	30.0

* Available on indent.

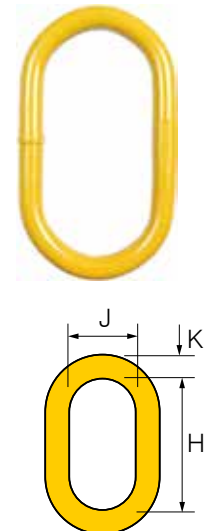

Classic round section welded Herc-Alloy Master Links are designed for chain or wire rope slings. Available in Regular and Large sizes.

- Complies with AS3776.
- Design factor 4:1 proof tested and certified.
- Manufactured in Australia. Product Code 02951159 manufactured in South Africa.

Master Link – Type KM



Product Code	KUPLEX Item No.	WLL	For G80 Chain	Dimensions (mm)				Weight
		t	1 Leg (mm)	A	B	D	S	kg
02439901	KM-A	1.6	7	152	76	17	12	0.47

A flat section Master Link suitable for use with 1-leg 7mm slings.

- For other sizes of Kuplex flat section master link, refer page 46.
- 4:1 design factor.
- Complies with EN1677.
- Connect to chain with Kupler Connecting Link or Yoke Omega Link.
- Manufactured in the U.K.

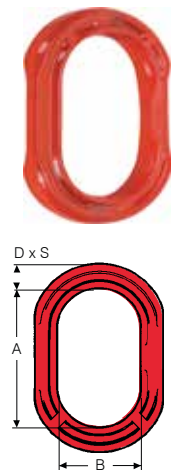

• Never exceed manufacturer's Working Load Limit (WLL).

MULTI OBLONG LINKS – 3 & 4 LEG SLINGS

Multi Link Assemblies – Small Droppers



Product Code	Drakena Code	For Chain		Dimensions (mm)			Dropper Dim. (mm)			Weight kg
		Ømm	t	d1	t1	w1	d2	t2	w2	
02265007	AK18	7	3.15	18	135	75	13	54	25	1.16
02265008	AK22	8	4.25	22	160	90	16	70	34	2.22
02265010	AK26	10	6.7	26	180	100	18	85	40	3.36
02265013	AK32	13	11.2	32	200	110	22	115	50	6.02
02265016	AK36	16	17.0	36	260	140	26	140	65	9.94
02265020	AK5132	20	26.5	51	350	190	32	150	70	23.3
02265022	AK5136	22	35.5	51	350	190	36	170	75	25.8
02265026	AK57	26	45.0	57	400	200	40	170	80	35.2

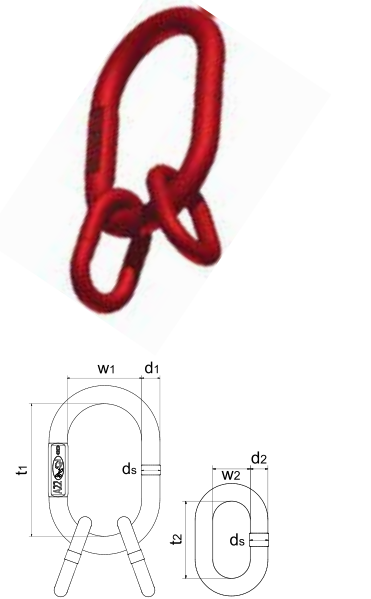

Designed for 3 and 4-leg chain assemblies.

- Red epoxy painted.
- Complies with EN1677-4.
- Manufactured in Germany.

Multi Link Assemblies – Large Droppers



Product Code	Drakena Code	WLL	Dimensions (mm)			Dropper Dimensions (mm)			Weight kg
		t	d1	t1	w1	d2	t2	w2	
02265101	AA1616	2.0	16	110	60	16	110	60	1.59
02265102	AA1816	3.0	18	135	75	16	110	60	1.86
02265103	AA2218	4.8	22	160	90	18	135	75	3.10
02265104	AA2622	7.8	26	180	100	22	160	90	5.30
02265105	AA3226	9.8	32	200	110	26	180	100	8.50
02265106	AA3626	11.8	36	260	140	26	180	100	10.95
02265107	AA3632	14.0	36	260	140	32	200	110	14.15
02265108	AA3636	16.5	36	260	140	36	260	140	19.05
02265109	AA4536	19.0	45	340	180	36	260	140	25.50
02265110	AA4545	25.0	45	340	180	45	340	180	38.40
02265111	AA5145	31.5	51	350	190	45	340	180	42.80

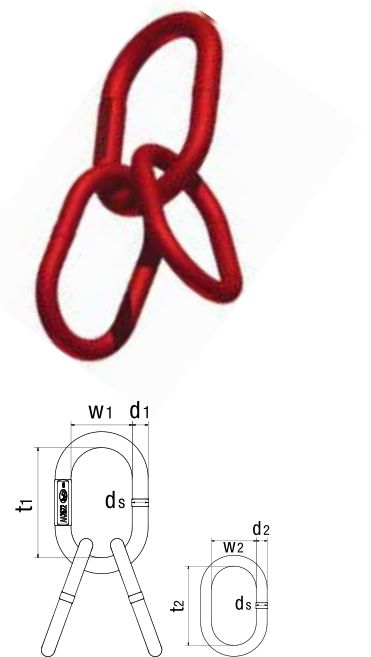

Large drop rings make these assemblies suitable for 3 and 4-leg wire rope and webbing slings.

- Red epoxy painted.
- Complies with EN1677-4.
- Manufactured in Germany.



• Never exceed manufacturer's Working Load Limit (WLL).

GRADE 80

PEAR LINKS

Clevis Pear Link – Type YG



Product Code	Yoke Item No.	WLL*	G80 Chain	Dimensions (mm)						Weight kg
		t	mm	A	G	H	K	L	T	
02470007	8-059-07	2.0	7, 8	9	65	15	99	80	15	0.4
02470010	8-059-10	3.15	10	11	80	18	125	100	19	0.8
02470013	8-059-13	5.3	13	14	108	22	168	136	25	1.5
02470016	8-059-16	8.0	16	18	124	26	198	158	27	2.4



Pear Links are commonly used in choking applications.

- Design factor 4:1 proof tested and certified.
- Complies with EN1677.
- Manufactured in Taiwan.

Example of Use:

Single Leg Reeveable Collar Chain Sling.

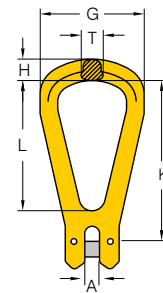
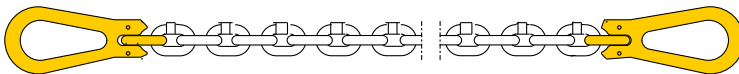

• When choked, the sling Working Load Limit must be reduced by 20%.

• Never exceed manufacturer's Working Load Limit (WLL).

CONNECTORS

Connecting Link – Type YA

YOKE

Product Code	Yoke Item No.	WLL	G80 Chain	Dimensions (mm)				Weight
		t	mm	A	B	D	K	kg
02459006	8-015-06	1.12	6	15	17	7	44	0.08
02459007	8-015-07	2.0	7, 8	18	22	9	57	0.2
02459010	8-015-10	3.15	10	25	26	11	68	0.3
02459013	8-015-13	5.3	13	30	35	16	91	0.7
02459016	8-015-16	8.0	16	36	38	19	100	1.1
02459019	8-015-20	12.5	18 – 20	42	46	22	122	1.9
02459022	8-015-22	15.0	22	49	59	24	152	3.0
02459026	8-015-26	21.2	26	55	62	30	162	5.0
02459032	8-015-32	31.5	32	69	79	36	202	9.0

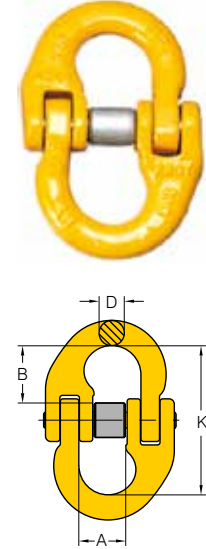

Provides a fast and safe means of assembling, dismantling and reassembling chain slings.



- Design factor 4:1 proof tested and certified.
- Complies with EN1677.



- Manufactured in Taiwan.

Spare Pin & Sleeve Set – To Suit Type YA

YOKE

Product Code	Yoke Item No.	Suits Connector
02459507	8-P015-07	02459007
02459510	8-P015-10	02459010
02459513	8-P015-13	02459013
02459516	8-P015-16	02459016
02459519	8-P015-20	02459019
02459522	8-P015-22	02459022
02459526	8-P015-26	02459026



- Manufactured in Taiwan.



- Never exceed manufacturer's Working Load Limit (WLL).
- Safe Use: Each connector body half should not have in use more than one load bearing component or chain.
- Avoid over-crowding to ensure load will be transmitted axially.

CONNECTORS

Connecting Link – Dacromet® Protection



Product Code	Yoke Item No.	WLL	G80 Chain	Dimensions (mm)				Weight
		t	mm	A	B	D	K	kg
02459310	8-M015-10	3.15	10	25	26	11	68	0.3
02459313	8-M015-13	5.3	13	30	35	16	91	0.7
02459316	8-M015-16	8.0	16	36	38	19	100	1.2
02459319	8-M015-20	12.5	18 – 20	42	46	22	122	1.9
02459322	8-M015-22	15.0	22	49	59	24	152	3.0
02459326	8-M015-26	21.2	26	55	62	30	162	4.6

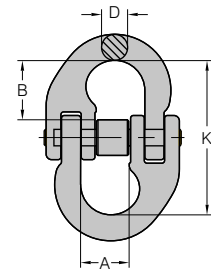

The special Dacromet® surface finish provides a high resistance to corrosion.



- Special pin and sleeve designed for regular re-use.
- Design factor 4:1 proof tested and certified.



- Complies with EN1677.
- Manufactured in Taiwan.

Spare Pin & Sleeve Set – To Suit Dacromet® Connector



Product Code	Yoke Item No.	Suits Connector
02459613	8-PM015-13	02459313
02459616	8-PM015-16	02459316
02459619	8-PM015-20	02459319
02459622	8-PM015-22	02459322



- Manufactured in Taiwan.



• Dacromet® Connecting Links have been proven effective in commercial trawling applications



- Never exceed manufacturer's Working Load Limit (WLL).
- Safe Use: Each connector body half should not have in use more than one load bearing component or chain.
- Avoid over-crowding to ensure load will be transmitted axially.

CONNECTORS

Component Connector – Type TL

Crosby® Kuplex®

Product Code	Kuplex Item No.	WLL	G80 Chain	Dimensions (mm)					Weight
		8 (t)	mm	A	B	C	D	E	kg
02419007	TL7	1.5	7	67	49	48	14.3	9	0.11
02419010	TL10	3.2	10	89	66	70	19.2	13	0.36
02419013	TL13	5.3	13	118	85	85	26.5	17	0.66
02419016	TL16	8.0	16	144	96	106	32.0	19	1.08
02419019	TL19	11.2	19	168	115	122	38.5	23	1.77
02419023	TL23	16.0	23	206	140	150	49.0	28	2.80
02419026	TL26	21.2	26	230	163	166	57.0	32	4.40
02419032	TL32	31.5	32	278	210	200	63.0	39	8.40

A general purpose link for connecting chain to eye-type components.

- Popular in trawling applications.
- Individually proof tested to 2.5 x WLL.
- 4:1 design factor.
- Manufactured in the U.K.

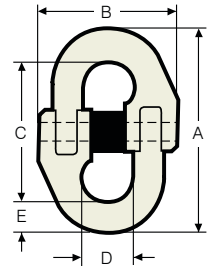

Spare Pin & Sleeve Set – To Suit Type TL Connector

Crosby® Kuplex®

Product Code	Kuplex Item No.	Suits Connector
02419710	TL10/3 – TL10/6	02419010
02419713	TL13/3 – TL13/6	02419013
02419716	TL16/3 – TL16/6	02419016
02419719	TL19/3 – TL19/6	02419019
02419723	TL23/3 – TL23/6	02419023
02419726	TL26/3 – TL26/6	02419026
02419732	TL32/3 – TL32/6	02419032



- Manufactured in the U.K.



• Crosby Kuplex TL Connectors have also been designed for the rigours of commercial fishing and proven effective over many years by a leading New Zealand deep sea fishing company.



- Never exceed manufacturer's Working Load Limit (WLL).
- Safe Use: Each connector body half should not have in use more than one load bearing component or chain.
- Avoid over-crowding to ensure load will be transmitted axially.

CONNECTORS

Unilock Bolt Type Connecting Link

Product Code	Pewag Item No.	WLL	G80 Chain	Dimensions (mm)						Weight
		t	mm	e	b	d	s	a	M	kg
02243506	U 5/6	1.12	5, 6	34	21	9.3	11	16	7	0.07
02243508	U 8	2.00	8	48	28	13	16	22	10	0.22
02243510	U 10	3.15	10	60	35	16	20	27	12	0.38
02243513	U 13	5.30	13	72	39	18	24	34	16	0.67



An alternative style of connecting link with bolt, washers and safety nut. Extensively used in the New Zealand forestry industry.

- Complies with EN1677.
- Manufactured in Austria.

Unilock Allowable Wear

Measure	Maximum Permitted Change
Bolt must be free to move	Changes are not permitted
e	+5%
d and M	-10%

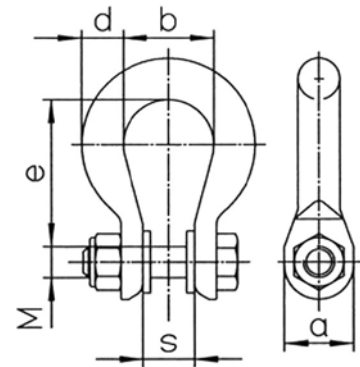

Unilock Assembly Instructions

The assembly may only be executed by a qualified person. Pewag Nicroman U Unilock connecting links are designed for the attachment of chains to master links/ master link assemblies or chains to hook.

After the assembly process, the U Unilock connecting link itself must also have sufficient mobility in order to be aligned to the direction of the load.

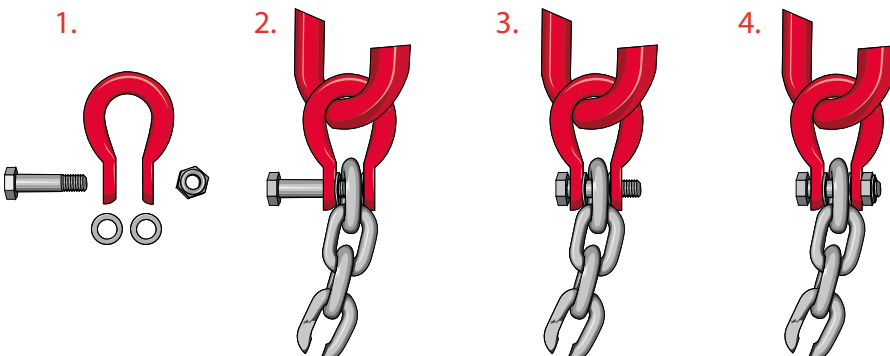

⚠️

- Never exceed manufacturer's Working Load Limit (WLL).
- Do not over-tighten nut.
- Bolt must rotate freely.

CONNECTORS

Omega Link – Type YO

YOKE

Product Code	Yoke Item No.	WLL	G80 Chain	Dimensions (mm)				Weight
		t	mm	D	K	P	T	kg
02471006	8-018-06	1.12	6	21	30	8	9	0.1
02471007	8-018-07	2.0	7,8	27	36	9	11	0.2
02471010	8-018-10	3.15	10	32	44	12	15	0.4
02471013	8-018-13	5.3	13	42	55	16	17	0.8
02471016	8-018-16	8.0	16	50	69	18	22	1.6
02471019	8-018-20	12.5	18 – 20	58	71	21	28	2.1

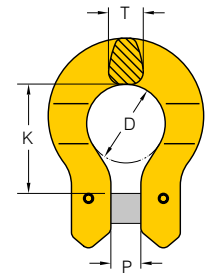

Use with Type MFF Masterlink, refer page 12.

- Design factor 4:1 proof tested & certified.
- Complies with EN1677.
- Manufactured in Taiwan.



Chain to Chain Connector – Type KJ

Crosby **Kuplex**

Product Code	Kuplex Item No.	WLL	G80 Chain	Dimensions (mm)					Weight
		t	mm	A	B	C	D	E	kg
02410007	KJ7	1.5	7	56	34	41	8	7.5	0.09
02410010	KJ10	3.2	10	73	45	51	11.5	11	0.27
02410013	KJ13	5.3	13	94	61	65	14.7	14	0.44
02410016*	KJ16	8.0	16	120	75	84	19.1	18	0.83
02410019*	KJ19	11.2	19	142	90	100	22.9	21	1.42

* Available on indent.

A flexible link for Grade 80 chain connection and suitable for making endless slings.

- 4:1 design factor.
- Complies with EN1677.
- Manufactured in the U.K.

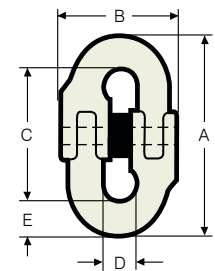

• Kuplex KJ Chain-to-Chain Connectors are suitable for fabrication of endless chain slings.



• Never exceed manufacturer's Working Load Limit (WLL).

CONNECTORS

Synthetic Sling Connector



Product Code	Yoke Item No.	WLL	G80 Chain	Dimensions (mm)					Weight
		t	mm	A	B	D	K	W	kg
02477007	8-016-07	2.0	7, 8	18	22	9	62	40	0.3
02477010	8-016-10	3.15	10	25	26	11	78	47	0.6
02477013	8-016-13	5.3	13	30	35	16	95	53	1.1
02477016	8-016-16	8.0	16	36	38	19	115	67	1.9
02477019	8-016-20	12.5	18 – 20	42	46	22	132	80	3.2
02477022	8-016-22	15.0	22	49	59	24	187	125	7.5
02477026	8-016-26	21.2	26	55	62	30	209	150	12.0

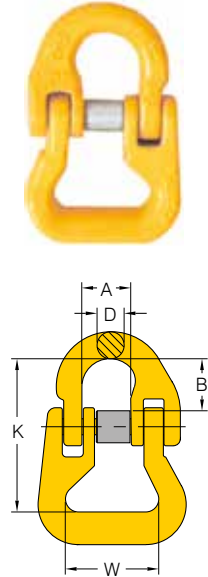

Ideal for flat web sling connections or attaching eye type hooks to endless roundslings as shown below.

- Design factor 4:1 proof tested and certified.
- Complies with EN1677.
- Manufactured in Taiwan.



 • Never exceed manufacturer's Working Load Limit (WLL).

SHORTENING CLUTCHES

Shortening clutches enable a multi-leg chain sling to have different leg lengths as required to adjust to the balance or required lifting angle of the load. Cookes offers several styles of shortening clutch to meet users preferences.

Clevis Clutch – Type KC



Product Code	Yoke Item No.	WLL	G80 Chain mm	Dimensions (mm)			Weight kg
		t		A	B	C	
02468007	8-060-07	2.0	7, 8	8	9	10	0.4
02468010	8-060-10	3.15	10	12	12	14	1.0
02468013	8-060-13	5.3	13	16	17	17	2.0
02468016	8-060-16	8.0	16	20	20	19	3.2
02468019	8-060-20	12.5	18 – 20	21	23	23	5.0

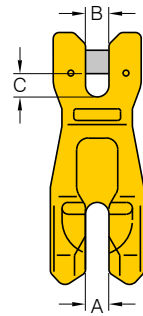

Conventional style clevis shortening clutch.

- Use with 3 links of chain to connector.
- Design factor 4:1 proof tested and certified.
- Complies with EN1677.
- Manufactured in Taiwan.



Clevis Locking Clutch – Type KCK



Product Code	Yoke Item No.	WLL	G80 Chain mm	Dimensions (mm)			Weight kg
		t		A	B	C	
02468107	8-061-07	2.0	7, 8	10	10	10	0.5
02468110	8-061-10	3.15	10	12	12	12	0.9
02468113	8-061-13	5.3	13	15	15	16	2.2
02468116	8-061-16	8.0	16	18	21	19	3.7
02468119	8-061-20	12.5	18 – 20	22	23	23	5.8

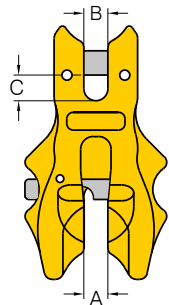

Includes spring locking latch to engage and retain chain safety.

- Use with 3 links of chain to connector.
- Design factor 4:1 proof tested & certified.
- Complies with EN1677.
- Manufactured in Taiwan.



- Clevis Grab Hooks for shortening – Grade 80 cradle type Grab Hooks with supporting wings may also be used as chain leg shortening devices with no derating of WLL. For specifications refer page 32.



- Never exceed manufacturer's Working Load Limit (WLL).
- Shortening clutches must be used correctly with the load bearing chain always leading out from the bottom of the clutch.
- Ensure no one leg is overloaded once legs are shortened.

GRADE 80

SHORTENING CLUTCHES

Shortening Clutch – with Half Link



Product Code	Yoke Item No.	WLL	G80 Chain	Dimensions (mm)								Weight
		t	mm	A	C	D	E	F	H	G	K	kg
02468507	8-078-07	2.0	7,8	12	20	10	23	70	22	9	128	0.7
02468510	8-078-10	3.15	10	13	26	12	29	87	26	11	154	1.3
02468513	8-078-13	5.3	13	15	33	16	37	115	36	15	203	2.8
02468516	8-078-16	8.0	16	21	39	19	46	143	39	19	248	5.3

Allows direct connection to master link.

- Design factor 4:1 proof tested and certified.
- Complies with EN1677.
- Manufactured in Taiwan.



• Clevis Grab Hooks for shortening – Grade 80 cradle type Grab Hooks with supporting wings may also be used as chain leg shortening devices with no derating of WLL. For specifications refer page 32.

• Never exceed manufacturer's Working Load Limit (WLL).
 • Shortening clutches must be used correctly with the load bearing chain always leading out from the bottom of the clutch.
 • Ensure no one leg is overloaded once legs are shortened.

HOOKS

Choosing the correct lifting hook.

The hook is a crucial element in ensuring safe lifting, therefore always give careful consideration to the type of lift, the shape of the load, and then select the hook best suited to the application.



Self Locking Hooks

May also be referred to as 'Safety Locking Hooks' or 'Latchlok Hooks'. Self locking hooks are designed to pivot in the middle and lock once the load is applied. It requires pressure on the trigger to release the hook when the load is grounded. The hook pivots fully open to give unrestricted access to the hook bowl. Always ensure the load is supported in the bowl of the hook.



Swivel Self Locking Hooks

Same operation as the conventional self locking hook but incorporates a bow and swivel assembly. Where the swivel action is required only to position a load choose a plain bearing model. When the swivel is required to rotate under load choose only a ball bearing model. Always ensure the load is supported in the bowl of the hook.



Safety Handle Self-Locking Hooks

A self-locking hook with added safety handle designed to eliminate the serious pinch and hand-trap hazards associated with traditional lifting hooks. Available as a standard eye type hook or with swivel top.



Sling Hooks

May also be referred to as 'Slip Hooks'. The sling hook was for many years the standard choice for lifting chains. It has been overtaken in popularity to some extent by the self locking hook but still remains very popular today. Always ensure the load is supported in the bowl of the hook and that the safety latch is engaged.



Swivel Sling Hooks

A version of the sling hook that incorporates a swivel assembly. When the swivel action is required only to position a load, choose a plain bearing model. When the swivel is required to rotate under load choose only a ball bearing model. Always ensure the load is supported in the bowl of the hook and that the safety latch is engaged.

HOOKS

Choosing the correct lifting hook.

The hook is a crucial element in ensuring safe lifting therefore always give careful consideration to the type of lift, the shape of the load, and then select the hook best suited to the application.



Grab Hooks

May also be referred to as a 'Snig Hook'. The narrow throat of a grab hook allows one link of chain to be seated and effectively grabbed. Grab hooks may be used to choke a load or are commonly used for shortening of chain legs. Always insist on the cradle type grab hook with supporting wings. Where used as a shortening device cradle type grab hooks maintain their full WLL. When cradle type grab hooks are used as bottom hooks for choking purposes, the sling WLL must be derated by 20%.



Foundry Hooks

Designed with a wide throat, these hooks are ideal for unusually bulky attachment points. Foundry hooks do not incorporate a safety latch. Under the Approved Code of Practice for Load Lifting Rigging, such hooks may only be used where fitting and removing of a load cannot be physically achieved with a hook incorporating a safety latch. It is the user's responsibility to ensure that a foundry hook is safe for the intended application and meets the requirements of the Code. Always ensure the load is supported in the bowl of the hook.



C Hooks

This style of hook has a projection over the hook tip intended to stave off obstructions which might otherwise foul the hook tip during lifting. C Hooks do not incorporate a safety latch. Under the Approved Code of Practice for Load Lifting Rigging, such hooks may only be used where fitting and removing of a load cannot be physically achieved with a hook incorporating a safety latch. Always ensure the load is supported in the bowl of the hook (for C Hooks to suit Grade 80 chain, refer Kuplex 8 + 10 C Hooks on page 62).

Safety Latches



- As detailed in the Approved Code of Practice for Load-Lifting Rigging (5th edition 2012): "Safety latches are to be fitted to hooks unless fitting and removal of the load cannot be physically achieved with a latch fitted, for example: using a molten metal pouring ladle in a steel works."

HOOKS

Clevis Self-Locking Hook – Type YD



Product Code	Yoke Item No.	WLL	G80 Chain	Dimensions (mm)					Weight
		t	mm	A	H	K	P	T	kg
02461006	8-026-06	1.12	6	6	19	100	29	15	0.5
02461007	8-026-07	2.0	7, 8	9	24	119	34	20	0.8
02461010	8-026-10	3.15	10	11	30	143	44	26	1.4
02461013	8-026-13	5.3	13	14	39	179	52	30	2.9
02461016	8-026-16	8.0	16	18	49	212	60	36	5.6
02461019	8-026-20	12.5	18 – 20	21	62	243	90	48	9.0
02461022	8-026-22	15.0	22	24	63	273	80	49	13.0

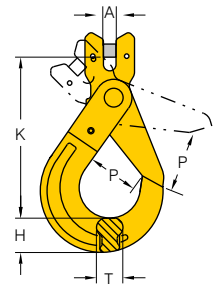

Designed so the latch cannot open under load and requires pressure on the trigger to release the hook when load is grounded. Latch trigger on rear of hook (refer image page 27).

- Complies with EN1677.
- Design factor 4:1 proof tested and certified.
- Replacement latch kits available.
- Manufactured in Taiwan.

Eye Self-Locking Hook – Type YC



Product Code	Yoke Item No.	WLL	G80 Chain	Dimensions (mm)						Weight
		t	mm	A	D	H	K	P	T	kg
02460006	8-025-06	1.12	6	21	10	19	110	29	15	0.5
02460007	8-025-07	2.0	7, 8	25	11	24	136	34	20	0.8
02460010	8-025-10	3.15	10	32	13	30	167	44	26	1.4
02460013	8-025-13	5.3	13	40	16	39	207	52	30	3.0
02460016	8-025-16	8.0	16	52	21	49	252	60	36	5.8
02460019	8-025-20	12.5	18 – 20	64	23	62	282	90	48	8.5
02460022	8-025-22	15.0	22	70	24	63	319	80	49	12.5
02460026	8-025-26	21.2	26	80	25	69	343	99	56	14.0
02460028	8-025-28	25.0	28	90	28	81	401	120	63	26.0

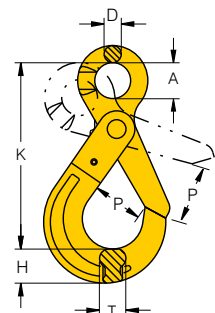

Designed so the latch cannot open under load and requires pressure on the trigger to release the hook when load is grounded. Latch trigger on rear of hook (refer image page 27).



- Complies with EN1677.
- Design factor 4:1 proof tested and certified.
- Replacement latch kits available.
- Manufactured in Taiwan.

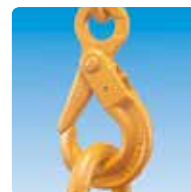

• Never exceed manufacturer's Working Load Limit (WLL).

HOOKS

Swivel Self-Locking Hook – Type YE (Plain Bearing)



Product Code	Yoke Item No.	WLL	G80 Chain	Dimensions (mm)							Weight kg
		t	mm	A	B	D	H	K	P	T	
02462007	8-027-07	2.0	7, 8	36	29	14	24	186	34	20	1.2
02462010	8-027-10	3.15	10	40	34	16	30	220	44	26	2.0
02462013	8-027-13	5.3	13	46	43	22	39	267	52	30	4.1
02462016	8-027-16	8.0	16	60	50	24	49	328	60	36	7.2
02462019	8-027-20	12.5	18 – 20	75	82	26	62	388	90	48	11.5
02462022	8-027-22	15.0	22	97	95	33	63	457	80	49	18.6
02462026	8-027-26	21.2	26	123	115	42	69	535	99	56	31.9

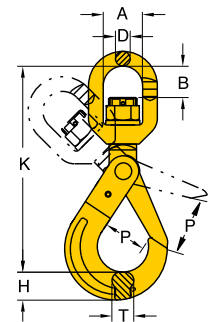

This hook is a positioning device only & is not intended to rotate under load.

Designed so the latch cannot open under load and requires pressure on the trigger to release the hook when load is grounded. Latch trigger on rear of hook (refer image below).

- With brass bush.
- Complies with EN1677.
- Design factor 4:1 proof tested and certified.
- Replacement latch kits available.
- Manufactured in Taiwan.

Swivel Self-Locking Hook – Type YEN (Ball Bearing)



Product Code	Yoke Item No.	WLL	G80 Chain	Dimensions (mm)							Weight kg
		t	mm	A	B	D	H	K	P	T	
02462007N	8-027N-07	2.0	7, 8	36	29	14	24	186	34	20	1.2
02462010N	8-027N-10	3.15	10	40	34	16	30	220	44	26	2.0
02462013N	8-027N-13	5.3	13	46	43	22	39	267	52	30	4.2
02462016N	8-027N-16	8.0	16	60	50	24	49	328	60	36	7.3
02462019N	8-027N-20	12.5	18 – 20	75	82	26	62	388	90	48	11.7
02462022N	8-027N-22	15.0	22	97	95	33	63	457	80	49	18.0
02462026N	8-027N-26	21.2	26	123	115	42	69	535	99	56	32.0

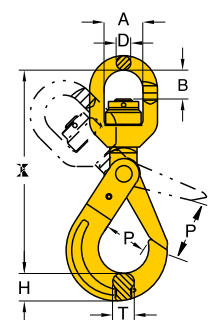

Designed so the latch cannot open under load and requires pressure on the trigger to release the hook when load is grounded. Latch trigger on rear of hook (refer image).



Push trigger to open hook.

- With Ball Bearings, which allows swivel to operate under load.
- Complies with EN1677.
- Design factor 4:1 proof tested and certified.
- Replacement latch kits available.
- Manufactured in Taiwan.



• Never exceed manufacturer's Working Load Limit (WLL).

HOOKS

Eye Swivel Self Locking Safety Handle Hook



Product Code	Nautilus Item No.	WLL	Chain Size (mm)		Dimensions (mm)				Weight
		t	G80	G100	L	H	W	O	kg
02445004S	NH-SL4S	4.0	10	10	242	32	156	47	3.1
02445008S	NH-SL8S	8.0	16	n.a.	374	50	208	60	7.5
02445012S	NH-SL12S	12.0	19	n.a.	408	60	225	72	9.4
02445016S	NH-SL16S	16.0	22	n.a.	422	65	235	82	11.6
02445020S	NH-SL20S	20.0	26*	n.a.	438	70	270	102	18.4



* Sling Working Load Limit must be adjusted to suit 20t maximum WLL on hook.

Eye Self Locking Safety Handle Hook



Product Code	Nautilus Item No.	WLL	Chain Size (mm)		Dimensions (mm)				Weight
		t	G80	G100	L	H	W	O	kg
02445004E	NH-SL4E	4.0	10	10	216	32	156	47	2.6
02445008E	NH-SL8E	8.0	16	n.a.	292	50	208	60	5.3
02445012E	NH-SL12E	12.0	19	n.a.	328	60	225	72	7.4
02445016E	NH-SL16E	16.0	22	n.a.	342	65	235	82	8.9
02445020E	NH-SL20E	20.0	26*	n.a.	386	70	270	102	15.0

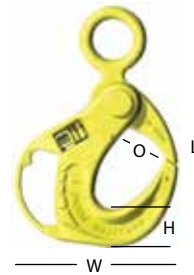

NAUTILUS™ HOOKS PROVIDE THE ULTIMATE SAFETY IN SELF-LOCKING LIFTING HOOKS.

- The safety features provide a unique and very simple operation.
- The integral handle protects operators' hands and removes them from the hook and sling interface area.
- Manufactured from high-grade carbon alloy steel.
- Corrosion-resistant stainless steel spring.
- Complies with EN1677.
- 4:1 design factor.
- Manufactured in the U.K.

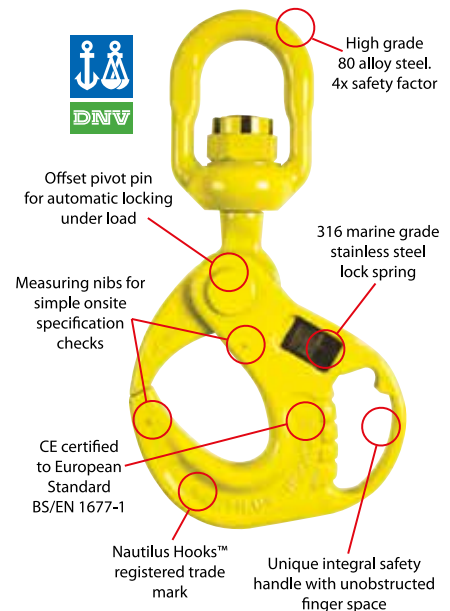

- Self-locking safety hooks with features which eliminate the risk of potentially serious pinch and trap hand injuries often associated with the use of traditional 'self-locking' hooks.



- Never exceed manufacturer's Working Load Limit (WLL).
- The Nautilus Safety Handle Hooks are positioning devices and are not intended to rotate under load.

HOOKS

Clevis Sling Hook – Type YM



Product Code	Yoke Item No.	WLL	G80 Chain	Dimensions (mm)					Weight
		t	mm	A	H	K	P1	T	kg
02472006	8-043/S-06	1.12	6	6	18	79	23	15	0.3
02472007	8-043/S-07	2.0	7, 8	9	22	98	27	18	0.6
02472010	8-043/S-10	3.15	10	11	29	121	34	23	1.2
02472013	8-043/S-13	5.3	13	14	37	147	44	30	2.3
02472016	8-043/S-16	8.0	16	18	42	166	48	39	3.7
02472019	8-043/S-20	12.5	18 – 20	21	50	200	56	47	6.5

- Includes safety latch.
- Replacement safety latch kits available.
- Complies with EN1677.
- Design factor 4:1 proof tested and certified.
- Manufactured in Taiwan.

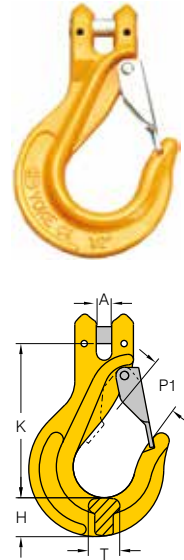

Eye Sling Hook – Type YP



Product Code	Yoke Item No.	WLL	G80 Chain	Dimensions (mm)					Weight	
		t	mm	A	D	H	K	P1	T	kg
02463006	8-044/S-06	1.12	6	20	9	20	80	23	16	0.3
02463007	8-044/S-07	2.0	7, 8	25	11	23	98	28	20	0.5
02463010	8-044/S-10	3.15	10	32	14	31	121	36	23	1.0
02463013	8-044/S-13	5.3	13	40	18	38	152	40	28	1.7
02463016	8-044/S-16	8.0	16	50	22	47	184	44	32	3.2
02463019	8-044/S-20	12.5	18 – 20	60	26	48	218	45	43	5.5
02463022	8-044/S-22	15.0	22	50	31	62	244	73	50	9.0
02463026	8-044/S-26	21.2	26	64	35	80	279	77	60	13.5
02463032	8-044/S-32	31.5	32	88	40	86	352	114	65	20.0



- Includes safety latch.
- Replacement safety latch kits available.
- Complies with EN1677.
- Design factor 4:1 proof tested and certified.
- Manufactured in Taiwan.

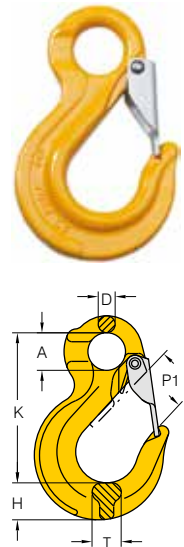

• Eye Sling Hooks are suitable for use on both lifting slings and winch cables.



• Never exceed manufacturer's Working Load Limit (WLL).

HOOKS

Extra Heavy Duty Granit-Super Clevis Sling Hook



Product Code	RUD Item No.	WLL	Suit Chain	Dimensions (mm)							Weight
		t	mm	A	B	C	D	F	G	T	kg
02900008	GSH - 8	2.00	8	38	28	20	28	30	98	97	0.8
02900010	GSH - 10	3.15	10	46	36	26	35	35	122	108	1.4
02900013	GSH - 13	5.30	13	58	46	30	37	40	139	126	2.5

The forged safety latch on the Granit-Super Hook slots into tip of hook, protecting it against bending sideways. Ergonomic design with finger-protecting actuating hollows.

- Extremely robust design.
- High bending resistance.
- Patented markings to show wear in the throat and bowl of the hook.
- Triple coiled double leg spring, stainless.
- Complies with EN1677..
- 4:1 design factor.
- Replacement safety latch kits available.
- Manufactured in Germany.

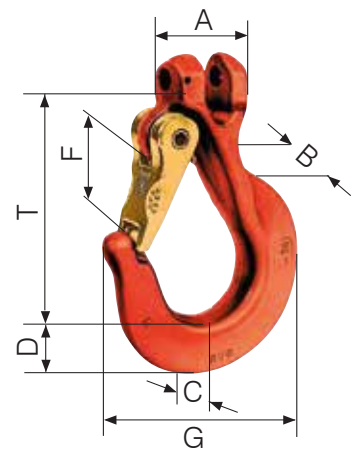

• Never exceed manufacturer's Working Load Limit (WLL).

HOOKS

Eye Swivel Sling Hook – Type YSW (Plain Bearing)



Product Code	Yoke Item No.	WLL	G80 Chain	Dimensions (mm)							Weight kg
		t	mm	A	B	D	H	K	P	T	
02464007	8-049-07	2.0	7, 8	36	27	12	22	155	26	18	0.9
02464010	8-049-10	3.15	10	41	37	16	29	189	36	23	1.6
02464013	8-049-13	5.3	13	46	40	21	35	233	42	28	3.2
02464016	8-049-16	8.0	16	60	50	22	44	280	50	35	5.3
02464019	8-049-20	12.5	18 – 20	74	82	25	65	356	56	49	9.5

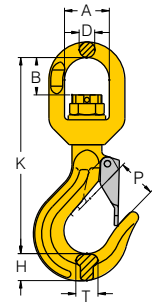

Conventional style sling hook incorporating a plain bearing for load positioning purposes only. This hook is not designed to swivel under load.

- Complies with EN1677.
- Design factor 4:1 proof tested and certified.
- Replacement safety latches available.
- Manufactured in Taiwan.

Eye Swivel Sling Hook – Type YSWN (Ball Bearing)



Product Code	Yoke Item No.	WLL	G80 Chain	Dimensions (mm)							Weight kg
		t	mm	A	B	D	H	K	P	T	
02464107	8-049N-07	2.0	7, 8	36	27	12	22	155	26	18	0.9
02464110	8-049N-10	3.15	10	41	37	16	29	189	36	23	1.6
02464113	8-049N-13	5.3	13	46	40	21	35	233	42	28	3.4
02464116	8-049N-16	8.0	16	60	50	22	44	280	50	35	5.1
02464119	8-049N-20	12.5	18 – 20	74	82	25	65	356	56	49	9.5

With Brush Bush

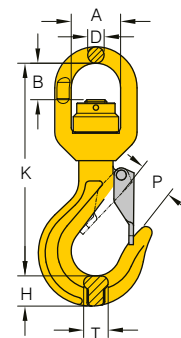

Conventional style sling hook incorporating a ball bearing swivel assembly which allows swivel to operate under load.

- Complies with EN1677.
- Design factor 4:1 proof tested and certified.
- Replacement safety latches available.
- Manufactured in Taiwan.

• Never exceed manufacturer's Working Load Limit (WLL).

HOOKS

Clevis Grab Hook – Type YK

YOKE

Product Code	Yoke Item No.	WLL	G80 Chain	Dimensions (mm)				Weight
		t	mm	A	H	K	P	kg
02467006	8-042-06	1.12	6	7	16	41	7	0.2
02467007	8-042-07	2.0	7, 8	9	25	55	10	0.3
02467010	8-042-10	3.15	10	12	35	77	13	0.8
02467013	8-042-13	5.3	13	15	42	97	16	1.6
02467016	8-042-16	8.0	16	17	45	102	20	2.8
02467019	8-042-20	12.5	18 – 20	23	54	124	23	4.8

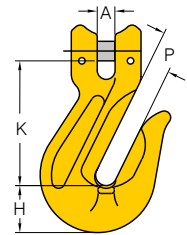

Supporting wings prevent chain link deformation. No reduction in WLL when used as a shortening device.

- Complies with EN1677.
- Design factor 4:1 proof tested and certified.
- Manufactured in Taiwan.

Eye Grab Hook – Type YH

YOKE

Product Code	Yoke Item No.	WLL	G80 Chain	Dimensions (mm)					Weight
		t	mm	A	F	G	K	P	kg
02467106	8-041-06	1.12	6	13	30	8	51	8	0.2
02467108	8-041-07	2.0	7, 8	15	30	9	60	10	0.3
02467110	8-041-10	3.15	10	20	41	13	84	13	0.6
02467113	8-041-13	5.3	13	25	52	15	102	16	1.4
02467116	8-041-16	8.0	16	30	57	20	114	20	2.3
02467119	8-041-20	12.5	18 – 20	36	73	24	132	23	3.9
02467122	8-041-22	15.0	22	38	70	26	165	26	4.7
02467126	8-041-26	21.2	26	41	100	32	187	29	9.9
02467132	8-041-32	31.5	32	61	127	40	230	37	21.4

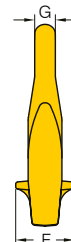
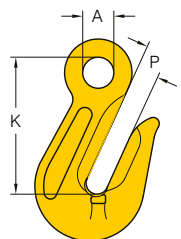

Supporting wings prevent chain link deformation. No reduction in WLL when used as a shortening device.

- Complies with EN1677.
- Design factor 4:1 proof tested and certified.
- Manufactured in Taiwan.



• Where grab hooks are fitted as bottom hooks or chain is choked, the sling WLL must be derated by 20%.



• Never exceed manufacturer's Working Load Limit (WLL).

HOOKS

Eye Foundry Hook – Type YN



Product Code	Yoke Item No.	WLL	G80 Chain	Dimensions (mm)						Weight
		t	mm	A	D	H	K	P	T	kg
02465007	8-047-07	2.00	7, 8	24	12	30	122	61	20	0.7
02465010	8-047-10	3.15	10	31	15	34	150	74	24	1.3
02465013	8-047-13	5.30	13	40	20	42	180	88	34	2.3
02465016	8-047-16	8.00	16	49	24	50	215	98	43	4.1
02465020	8-047-20	12.5	18 – 20	60	28	57	248	112	46	9.3

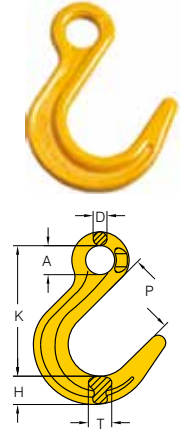

Designed with wide throat.

- Complies with EN1677.
- Design factor 4:1 proof tested and certified.
- Manufactured in Taiwan.

Clevis Forestry Choker Hook – Type YT



Product Code	Yoke Item No.	WLL	G80 Chain	Dimensions (mm)					Weight
		t	mm	A	C	K	P	T	kg
02475007	8-075-07	2.00	7, 8	9	32	58	10	18	0.5
02475010	8-075-10	3.15	10	13	45	82	12	21	0.9
02475013	8-075-13	5.30	13	14	47	100	16	27	1.7

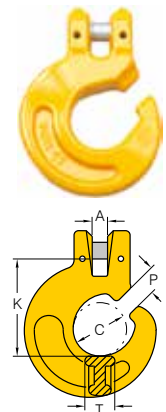

Designed for forestry use and should not to be used in overhead lifting applications.

- Design factor 4:1.
- Tested and certified.
- Manufactured in Taiwan.

Sliding Choke Hook – Type KF



Product Code	Yoke Item No.	WLL	For wire rope	Dimensions (mm)					Weight
		t	mm	A	E	H	P	S	kg
02249102	8-074-09/13	1.5	9-13	16	87	24	18	18	0.6
02249103	8-074-14/16	2.2	14-16	21	98	29	20	22	0.9

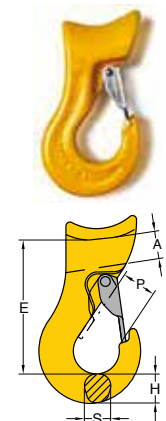

Sliding Choke Hook with wide throat, making them perfect for wire rope rigging applications.

- Design factor 5:1.
- Manufactured in Taiwan.



• Never exceed manufacturer's Working Load Limit (WLL).



• Foundry Hooks do not include a safety latch and may only be used where fitting and removing of a load cannot be physically achieved with a hook incorporating a safety latch.
 • Forestry Choker Hooks are designed for forestry applications and should not be used in overhead lifting applications.

HOOKS

Weld-on Hook – Type YX



Product Code	Yoke Item No.	WLL	Dimensions (mm)							Weight
		t	A	H	L	M	P	T	W	kg
02465001	8-081-01	1.0	7	27	72	6	18	17	95	0.6
02465002	8-081-02	2.0	8	31	88	8	25	20	115	1.0
02465003	8-081-03	3.0	9	30	107	10	28	23	133	1.4
02465004	8-081-04	4.0	10	38	112	11	28	30	141	2.0
02465005	8-081-05	5.0	12	46	133	13	30	31	167	3.0
02465008	8-081-08	8.0	12	54	137	14	32	39	175	3.8
02465011	8-081-10	10.0	13	56	168	16	44	42	222	6.3

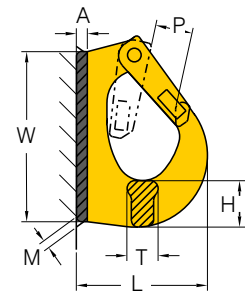

The Working Load Limit (WLL) should be reduced to meet any appropriate legislative requirements if welding on to an excavator. Refer following page for welding instructions.

- Replacement latches available.
- Design factor 5:1 proof tested and certified.
- Manufactured in Taiwan.

Replacement Latch Kits available. Refer page 37.

Eye Container Hook – Type KA



Product Code	Yoke Item No.	Description	WLL	Dimensions (mm)			Weight
			t	E	F	K	kg
02466005	8-067-STR	Straight	12.5	70	45	192	3.9
02466001	8-067-45LT	Left 45°	12.5	70	45	192	3.9
02466002	8-067-45RH	Right 45°	12.5	70	45	192	3.9

- Design factor 4:1
- Proof tested and certified.
- Complies with EN1677.
- Manufactured in Taiwan.

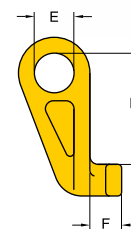

• Never exceed manufacturer's Working Load Limit (WLL).

WELDING INSTRUCTIONS FOR YOKE WELD-ON HOOK – TYPE YX

SUPPORT MATERIAL

- The material of the welding block is S355J2+N (1.0577+N, St 52-3N, B.S. 4360.50D, AISI 1019 etc.).
- Prior to welding, the contact areas must be free from impurities, oil, paint, rust, scale, etc. All rust must be completely removed from the weld area. Painted surface must be prepared in the same way.
- The steel support member must have a carbon content of no more than 0.40%.
- If the ambient temperature is 10°C or below, pre-heating of the weld area prior to welding must be carried out.

SEAM WELDING

- The welds must be sufficiently strong to take the required loads.
- Before starting the final weld pass, clean the root pass thoroughly to avoid inclusions.
- The complete welding operation must be carried out continuously so that the parts do not have time to cool.
- Effects of temperature:
 - The complete construction can be annealed stress release at <600°C without reduction of WLL.
 - Do not rapidly cool the weld.
- A thorough inspection of the weld should be performed. No cracks, pitting, inclusions, notches or undercuts are allowed. If doubt exists, use a suitable NDT method, such as magnetic particle or liquid penetrant to verify.
- If repair is required, grind out the defect and re-weld using the original qualified procedure.

WELDING MATERIALS

- Weld materials must have a minimum tensile strength of 70,000 PSI (such as AWS A5.1 E-7018), following the electrode manufacturer's recommendations. Reference information as below.
MIG arc welding:
 - Wire diameter 0.8-1.2 as per DIN 8559-SG 3, AWS A 5.18.



- Welding should only be carried out by a suitably qualified welder.
- Do not weld in the open air during bad weather.

TRIGGER KITS & SAFETY LATCH KITS

Replacement Trigger Kits for Self-Locking Hooks



Product Code	Yoke Item No.	Suits Yoke G80 Hook Types	Size
			mm
02461506	8-P025-06	YD, YC, YE, YEN	6
02461507	8-P025-07	YD, YC, YE, YEN	7 – 8
02461510	8-P025-10	YD, YC, YE, YEN	10
02461513	8-P025-13	YD, YC, YE, YEN	13
02461516	8-P025-16	YD, YC, YE, YEN	16
02461519	8-P025-20	YD, YC, YE, YEN	18 – 20
02461522	8-P025-22	YD, YC, YE, YEN	22
02461526	8-P025-26	YD, YC, YE, YEN	26



- Designed for use with both Grade 80 and Grade 100 Yoke Self-Locking Hooks.
- Manufactured in Taiwan.

Replacement Latch Kits for Sling Hooks



Product Code	Yoke Item No.	Suits Yoke G80 Hook Types	Size
			mm
02472506	8-P044-06	YP, YM	6
02472507	8-P044-07	YP, YM	7 – 8
02472510	8-P044-10	YP, YM	10
02472513	8-P044-13	YP, YM	13
02472516	8-P044-16	YP, YM	16
02472519	8-P044-20	YP, YM	18 – 20
02472522	8-P044-22	YP, YM	22
02472526	8-P044-26	YP, YM	26
02472532	8-P044-32	YP, YM	32



- Designed for use with both Grade 80 and Grade 100 Yoke Sling Hooks.
- Manufactured in Taiwan.

TRIGGER KITS & SAFETY LATCH KITS

Replacement Safety Latch Kits for Swivel Sling Hooks



Product Code	Yoke Item No.	Suits Yoke G80 Hook Types	Size
			mm
02472607	8-P049-07	YSW, YSWN	7
02472610	8-P049-10	YSW, YSWN	10
02472613	8-P049-13	YSW, YSWN	13
02472616	8-P049-16	YSW, YSWN	16
02472619	8-P049-20	YSW, YSWN	18 – 20



- Manufactured in Taiwan.

Replacement Latch Kits for Weld-on Hooks



Product Code	Yoke Item No.	Suits Yoke Hook Product Code	Size
			mm
02465201	8-P081-01	02465001	1
02465202	8-P081-02	02465002	2
02465203	8-P081-03	02465003	3
02465204	8-P081-04	02465004	4
02465205	8-P081-05	02465005	5
02465208	8-P081-08	02465008	8
02465210	8-P081-10	02465011	10



- Manufactured in Taiwan.

Latch Kits for Extra Heavy Duty Granit-Super Hooks



Product Code	RUD Item No.	Suits RUD Hook Product Code	Size
			mm
02900108	GSH-8-LK	02900008	8
02900110	GSH-10-LK	02900010	10
02900113	GSH-13-LK	02900013	13



- Manufactured in Germany.

CLEVIS SHACKLES

Clevis Shackle – Type YR



Product Code	Yoke Item No.	WLL	G80 Chain	Dimensions (mm)						Weight
		t	mm	A	C	K	L	M	W	kg
02478007	8-066-07	2.0	7,8	9	79	59	35	16	33	0.4
02478010	8-066-10	3.15	10	11	93	78	48	20	34	0.8
02478013	8-066-13	5.3	13	14	118	98	64	22	49	1.4
02478016	8-066-16	8.0	16	18	141	112	69	28	60	2.4

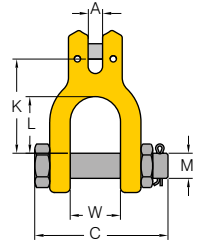

Designed for use as a terminal end fitting with clevis for direct connection to chain.

- Wide jaw.
- Fitted with safety pin and cotter pin to avoid dislodgement.
- Complies with EN1677.
- Design factor 4:1 proof tested and certified.
- Manufactured in Taiwan.



- Clevis Shackles negate the requirement for a separate shackle to be used.
- Perfect for connecting chain slings to the likes of plate lifting clamps.
- Grade 100 Clevis Shackles are also available in various styles, refer page 65.



- Never exceed manufacturer's Working Load Limit (WLL).

INSULATED SWIVELS

Insulated Swivels – Type 8-123



Product Code	Yoke Item No.	WLL	G80 Chain	Dimensions (mm)			Weight
		t	mm	A	D	L	kg
02469007	8-123-07	2.0	7, 8	18	9	131	0.7
02469010	8-123-10	3.15	10	25	11	162	1.5
02469013	8-123-13	5.3	13	30	16	214	3.2
02469016	8-123-16	8.0	16	36	19	243	5.4
02469019	8-123-20	12.5	18 – 20	42	22	285	9.0



- Supplied with two Half Links
- Ball bearing allows unit to swivel under load.
- Design factor 4:1 proof tested and certified.
- Complies with EN1677.
- Manufactured in Taiwan.

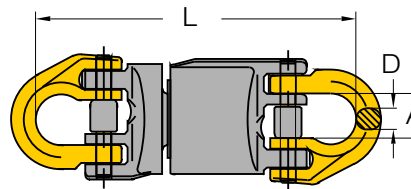

YOKE INSULATION SOLUTION

The Yoke Insulated Swivel is designed to provide for protection during overhead crane or electric hoist welding operations.

- Heavy hoisting with a strong but lightweight system.
- Fully rotational at maximum Working Load Limit (WLL)
- Individual swivels are 100% proof load tested to a minimum of 2.5 times the Working Load Limit.
- All swivels are individually tested during manufacturing to assure 1,000 Volts insulating property.
- Test certificate is packed with each unit.
- Acquired certificate approved by Deutsche Gesetzliche Unfallversicherung (DGUV).

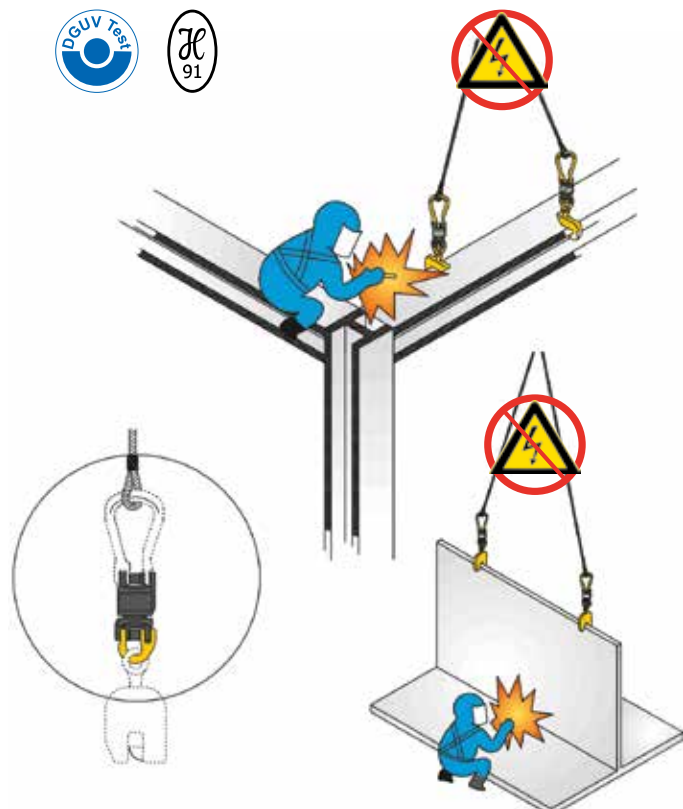

1,000 VOLTS RESISTANCE!



• Never exceed manufacturer's Working Load Limit (WLL).

LOAD PIN KITS

Load & Retainer Pin Sets



Product Code	Yoke Item No.	Suits Yoke Clevis Component Types	Size
			mm
02474007	8-P026-07	YG, YD, YM, YK, YT, YR, KC, KCK	7 – 8
02474010	8-P026-10	YG, YD, YM, YK, YT, YR, KC, KCK	10
02474013	8-P026-13	YG, YD, YM, YK, YT, YR, KC, KCK	13
02474016	8-P026-16	YG, YD, YM, YK, YT, YR, KC, KCK	16
02474019*	8-P026-20	YG, YD, YM, YK, YT, YR, KC, KCK	18 – 20
02474022	8-P026-22	YG, YD, YM, YK, YT, YR, KC, KCK	22



* Note: 02474019 (8-P026-20) can't be used with 20mm Clevis Grab Hook (02467019) or 20mm Clevis Clutch (02468019).

- Kit consists of one Load Pin and two Retaining Pins.
- Load Pins individually inspected after manufacture.
- Manufactured in Taiwan.



• Cookes recommend that load pins and retaining pins are replaced whenever clevis components are refitted.



• For use with specified Yoke components only

CHAIN SLING WORKING LOAD LIMITS

The Uniform Method for Rating GRADE 100 Chain Slings

Lifting Mode	1 Leg	2 Leg			3 & 4 Leg – Same Ratings		
Chain Ø	Factor 1	Factor 1.7	Factor 1.4	Factor 1	Factor 2.6	Factor 2.1	Factor 1.5
mm	0°	60°	90°	120°	60°	90°	120°
6.00	1.50	2.55	2.10	1.50	3.90	3.15	2.25
7.00	2.00	3.40	2.80	2.00	5.20	4.20	3.00
8.00	2.50	4.25	3.50	2.50	6.50	5.25	3.75
10.00	4.00	6.80	5.60	4.00	10.40	8.40	6.00
13.00	6.70	11.40	9.40	6.70	17.40	14.00	10.00
16.00	10.00	17.00	14.00	10.00	26.00	21.00	15.00
19.00	14.00	23.80	19.60	14.00	36.40	29.40	21.00
20.00	16.00	27.20	22.40	16.00	41.60	33.60	24.00
22.00	19.00	32.30	26.50	19.00	49.40	39.90	28.50
26.00	21.00	35.70	29.50	21.00	59.80	44.00	31.50
32.00	26.50	45.00	37.10	26.50	68.90	55.70	39.80
32.00	40.00	68.00	56.00	40.00	104.00	84.00	60.00

WORKING LOAD LIMITS (TONNES)

The Working Load Limits (WLL) listed in the table above are the maximum weights which slings are designed to sustain in general lifting service according to the standard Uniform Load Method of rating. General purpose chain slings must always be rated by the Uniform Method. Under this method, four-leg chain slings have the same WLL rating as three-leg slings based on an assumption that at least one leg of a four-leg sling may not be accepting its full share of the load.

In exceptionally hazardous conditions or in any other circumstances which might indicate a need for the Working Load Limit lower than the designated figure, the degree of hazard should be assessed by a competent person and a Safe Working Load (SWL) determined.

RATING SPECIAL PURPOSE CHAIN SLINGS BY THE TRIGONOMETRIC METHOD

The alternative Trigonometric Method may only be used where a multi-leg sling is to be used for a specific lifting application, with the angle between the legs pre-determined and constant. In such cases the WLL can be calculated on the basis of the specific angle specified and the chain sling will be tagged accordingly.



• For further information on trigonometric rating of chain slings, please contact your local Cookes branch, Freephone 0508 274 366 or email customerservices@bridoncookes.co.nz.



• When slings are used in a choke hitch or grab hooks fitted as bottom hooks, the WLL must be reduced by 20%.
• For G80 sling ratings refer to page 9.



• Never exceed manufacturer's Working Load Limit (WLL).
• Never use a chain assembly for lifting unless it has been tagged and certified by a reputable supplier.
• Never exceed 120° included sling angle between legs.

GRADE 100

LIFTING CHAIN

Kito Peerless Grade 100 Alloy Chain



Product Code	Nominal Size	WLL t	Inside Link Dimension (mm)		Approx. Weight kg / mtr
	mm		Length (Nom)	Width (Min)	
02399406	6	1.4	18	7.80	0.83
02399407	7	1.9	21	9.10	1.17
02399408	8	2.5	24	10.40	1.51
02399410	10	4.0	30	13.00	2.40
02399413	13	6.7	39	16.90	4.00
02399416	16	10.0	48	20.80	6.00
02399420	20	16.0	60	26.00	9.21
02398922	22	19.0	69	32.00	11.80
02398926	26	26.5	79	36.07	15.00



- A rugged high strength Alloy Steel chain.
- Designed to meet dimensional requirements of EN818-2.
- Fully tested and certified.
- Sizes 6mm - 20mm manufactured by Kito Weissenfels, Italy
- Sizes 22mm and 26mm manufactured by Kito Peerless, USA

Kuplex Grade 100 Alloy Chain



Product Code	Nominal Size	WLL t	Inside Link Dimension (mm)		Approx. Weight kg / mtr
	mm		Length (Nom)	Width (Min)	
02400107	7	2.0	21	9.1	1.09
02400110	10	4.0	30	13.0	2.20
02400113	13	6.7	39	16.9	3.62
02400116	16	10.0	48	20.8	5.42
02400119	19	14.0	57	24.7	7.96
02400123	23	21.0	69	29.9	11.83
02400126	26	27.0	78	33.8	14.99
02400132	32	40.0	96	41.6	21.99



- Heat treated, high strength Alloy Steel chain.
- High wear and fatigue properties.
- Designed to meet dimensional requirements of EN818-2 and ISO3076.
- Rust preventative coating.
- Fully tested and certified.
- Manufactured in France.



• Never exceed manufacturer's Working Load Limit (WLL).

GRADE 100

MASTER LINKS & MULTI OBLONG LINKS

Highest quality master links from world leading manufacturers.



MASTER LINKS – 1 LEG SLINGS

Kuplink – Type KS

Crosby  Kuplex

Product Code	KUPLEX Item No.	WLL	Suit Chain	Dimensions (mm)					Weight
		t	Ø (mm)	A	B	R	D	S	kg
02404907	KS7N	2.0	7	152	76	178	17	13	0.64
02404910	KS10N	4.0	10	152	76	190	22	16	1.15
02404913	KS13N	6.7	13	178	108	220	28	21	2.13
02404916	KS16N	10.0	16	228	127	285	38	27	4.69



A flat section Master Link for single leg slings that dispenses with the need for a separate connector.

- Clevis for direct connection to chain.
- 4:1 design factor.
- Complies with EN1677.
- Manufactured in the U.K.

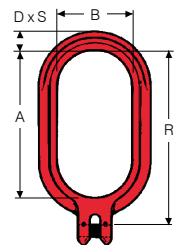

• The Kuplex Kuplink allows quick and easy assembly of single leg chain slings.



• Never exceed manufacturer's Working Load Limit (WLL).

MASTER LINKS – 1 & 2 LEG SLINGS

Oblong Master Link – Type X-003



Product Code	Yoke Item No.	WLL β 0-45°	For G100 Chain (mm)		Dimensions (mm)			Weight
		t	1 Leg	2 Leg	D	IL	IW	kg
02456707	X-003-0806	2.9	7, 8	6	14	120	70	0.5
02456710	X-003-1008	5.3	10	7, 8	17	140	80	0.7
02456713	X-003-1310	8.4	13	10	22	160	95	1.5
02456716	X-003-1613	14.1	16	13	28	180	105	2.7
02456719	X-003-19	16.0	19, 20	—	30	200	120	3.5
02456722	X-003-2216	21.0	22	16	34	240	140	5.3
02456725	X-003-26	26.5	26	—	38	250	150	7.4
02456726	X-003-2619	33.6	26	19, 20	40	250	150	8.2
02456732	X-003-3222	39.9	32	22	45	300	180	12.3

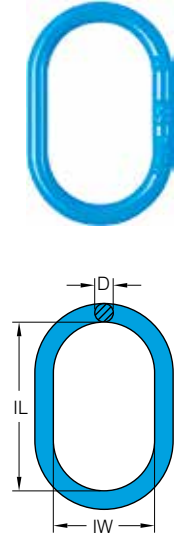

Yoke Master Links are suitable for single and double leg slings fabricated from chain, wire rope, webbing and fibre rope.

- Forged alloy steel.
- Design factor 4:1 proof tested and certified
- Manufactured in Taiwan.



Oblong Master Link – Large Series

Product Code	Manufacturers Item No.	WLL	For G100 Chain (mm)		Dimensions (mm)			Weight
		+	1 Leg	2 Leg	L	E	D	kg
02265413	MHF-1310-10	7.5	13	10	230	125	22	1.9
02265416	MHF-1613-10	10	16	13	250	135	28	3.2
02265420	MHF 2016-10	17	20	16	280	135	32	4.6
02265422	MHF 2220-10	28	-	20	320	175	40	8.6

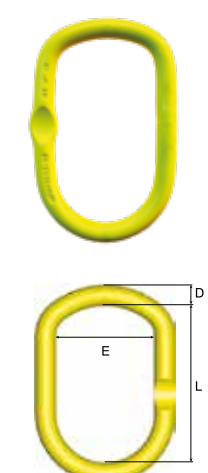

Hybrid series master link with larger radius ensuring a perfect fit on the crane hook.

- Ensures less wear and tear on the crane hook and the master link.
- Shape allows master link to automatically centre the load.
- Design factor 4:1
- Manufactured in Sweden.

• Grade 100 Master Links are also suitable for use on Wire Rope sling assemblies.
 • Sling eyes must be able to articulate freely on the master link – refer your nearest Cookes branch for assistance and advice.

• Never exceed manufacturer's Working Load Limit (WLL).

MASTER LINKS – 1 & 2 LEG SLINGS

Master Link – Type KM

Grosby  Kuplex

Product Code	KUPLEX Item No.	WLL	Dimensions (mm)				Weight
		t	A	B	D	S	kg
02439902	KM-B	4.2	152	76	22	14	0.81
02439903	KM-C	8.4	178	108	30	20	1.70
02439904	KM-D	14.0	228	127	40	27	4.06
02439905	KM-E	21.2	254	140	45	28	5.76
02439906	KM-F	30.0	305	171	53	36	10.56
02439907	KM-G	44.0	305	203	69	40	16.58
02439908	KM-HN	57.0	340	210	74	48	22.02

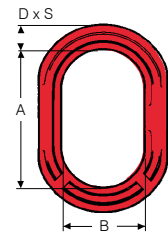

A flat section Master Link suitable for use with 1 and 2 leg slings.

- 4:1 design factor.
- Complies with EN1677.
- Connect to chain with Kupler Connecting Links (refer page 51).
- Manufactured in the U.K.

Kuplex® KM Series Usage Table for G100 Chain Slings

Reference	Single Leg	Two Leg
KM-B	7/10	7
KM-C	13	10
KM-D	16/19	13/16
KM-E	22/23	19
KM-F	26	23
KM-G	32	26
KM-HN	32	32

Auxillary Link – Type KAL

Grosby  Kuplex

Product Code	KUPLEX Item No.	WLL	Dimensions (mm)					Weight
		t	R	C	A (DIA)	D	S	kg
02440907	KAL7	3.2	79	31	34	17	12	0.52
02440910	KAL10	6.4	110	44	46	24	17	1.74
02440913	KAL13	10.8	143	57	60	30	21	2.89
02440916	KAL16	16	187	71	76	37	26	6
02440919	KAL19	23	232	90	90	44	31	10.25

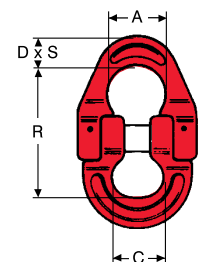

A mechanically assembled link allowing fabrication of 3 and 4 leg slings when used in conjunction with KM series Master Link above.

- 4:1 design factor.
- Complies with EN1677.
- Manufactured in the U.K.



• Never exceed manufacturer's Working Load Limit (WLL).

MULTI OBLONG LINKS – 3 & 4 LEG SLINGS

Multi Link Assemblies – Small Droppers



Product Code	Drakena Code	For Chain	WLL (t)	Dimensions (mm)			Dimensions (mm)			Weight kg
		Ømm	0-45°	d1	t1	W1	d2	t2	W2	
02265207	XDAK18	7	4.0	18	135	75	13	54	25	1.16
02265208	XDAK22	8	5.3	22	160	90	16	70	34	2.22
02265210	XDAK26	10	8.0	26	180	100	18	85	40	3.36
02265213	XDAK32	13	14.0	32	200	110	22	115	50	6.02
02265216	XDAK36	16	21.2	36	260	140	26	140	65	9.94
02265220	XDAK5132	20	33.6	51	350	190	32	150	70	23.3
02265222	XDAK5136	22	40.0	51	350	190	36	170	75	25.8
02265226	XDAK57	26	55.65	57	400	200	40	170	75	35.2

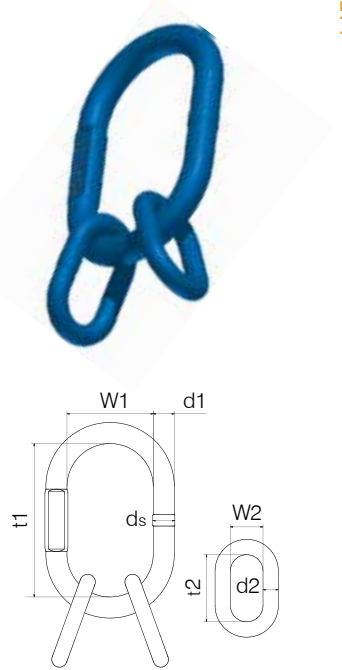

Designed for 3 and 4-leg chain sling assemblies.

- Manufactured in accordance with EN1677-4.
- 4:1 design factor.
- Blue epoxy painting.
- Manufactured in Germany

Multi Link Assemblies For Large Crane Hook



Product Code	Drakena Code	For Chain	WLL	Dimensions (mm)			Dimensions (mm)			Weight kg
		Ømm	t	d1	t1	w1	d2	t2	w2	
02265310	XDK25t/4-10	10	8.0	30	340	180	18	135	75	7.07
02265313	XDK25t/4-13	13	14.0	40	340	180	22	160	90	13.00
02265316	XDK25t/4-16	16	21.2	40	340	180	26	180	100	14.59

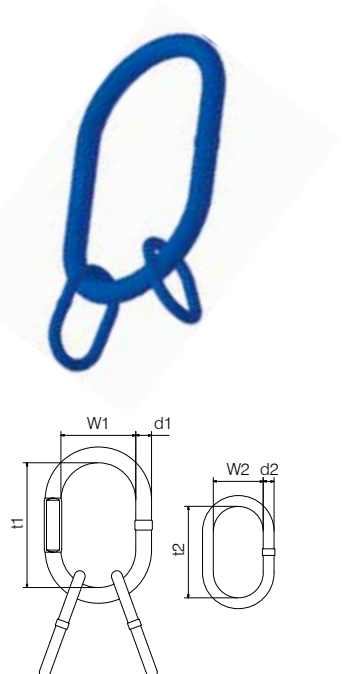

Oversized to suit large Crane Hooks. Designed for 3 and 4-leg sling assemblies.

- Generous main link dimensions to suit larger crane hooks to DIN15401.
- Manufactured in accordance with EN1677-4.
- 4:1 design factor.
- Blue epoxy painting.
- Manufactured in Germany.



• Never exceed manufacturer's Working Load Limit (WLL).

MULTI OBLONG LINKS – 3 & 4 LEG SLINGS

Litalink – Type KMML

Grosby  Kuplex

Product Code	KUPLEX Item No.	WLL	Suit Chain	Dimensions (mm)				Weight
		t	Ø (mm)	Link A	Link B	D x S	B Ø	kg
02443901	KMML7	4.2	7	152 x 76	63 x 34	22 x 14	13.0	1.15
02443902	KMML10	8.4	10	178 x 108	86 x 44	30 x 20	20.0	2.90
02443903	KMML13	14.0	13	228 x 127	113 x 70	40 x 27	26.0	6.18
02443904	KMML16	21.2	16	254 x 140	135 x 70	45 x 28	32.5	10.76
02443905	KMML19	30.0	19	305 x 171	155 x 85	53 x 36	38.0	20.00
02443906	KMML23	44.0	23	305 x 203	175 x 105	69 x 40	47.0	35.00
02443907	KMML26	57.0	26	340 x 210	220 x 135	74 x 48	55.0	48.00

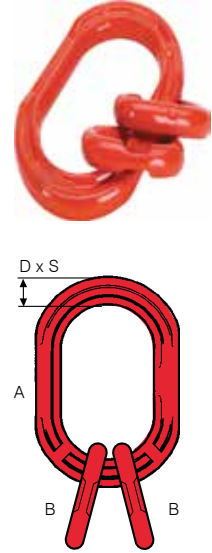

A traditional Kuplex® flat section multi-oblong link.

- Designed for use with 3 and 4-leg chain sling assemblies.
- Complies with EN1677.
- 4:1 design factor.
- Connect to chain with Kupler Connecting Links (refer page 51).
- Manufactured in the U.K.



Examples of 3 and 4-leg Kuplex Slings with KMML Multi-Oblong Link:



3-Leg Kuplex chain sling fitted with KSCN Shortening Clutches and KHNL Sling Hooks..

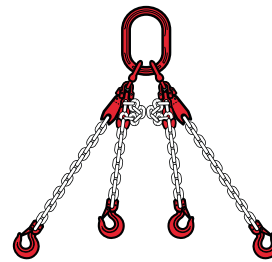

4-Leg Kuplex chain sling fitted with KSCN Shortening Clutches and KHNL Sling Hooks.



• Never exceed manufacturer's Working Load Limit (WLL).

PEAR LINKS

Clevis Pear Link – Type X-059



Product Code	Yoke Item No.	WLL*	G100 Chain	Dimensions (mm)						Weight kg
		t	mm	A	G	H	K	L	T	
02470707	X-059-07	2.5	7, 8	9	65	15	99	80	15	0.4
02470710	X-059-10	4.0	10	11	80	18	125	100	19	0.8
02470713	X-059-13	6.7	13	14	108	22	168	136	25	1.5
02470716	X-059-16	10.0	16	18	124	26	198	158	27	2.4

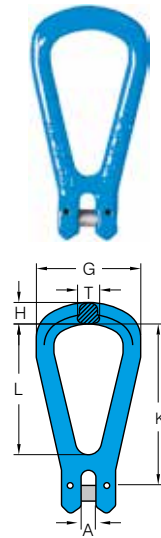

Pear Links are commonly used in choking applications.

- Fully reeveable and compact.
- Design factor 4:1 proof tested and certified.
- Manufactured in Taiwan.

Clevis Pear Link – Type KSS



Product Code	KUPLEX Item No.	WLL*	Dimensions (mm)					Weight kg
		t	A	B	R	D	S	
02409907	KSS7N	2.0	70	35	92	14	10	0.27
02409910	KSS10N	4.0	102	51	132	19	14	0.74
02409913	KSS13N	6.7	137	67	177	26	20	1.92
02409916	KSS16N	10.0	172	83	220	32	24	3.17
02409919	KSS19N	14.0	203	98	261	38	28	5.58
02409923	KSS23N	21.0	238	114	305	40	38	8.42

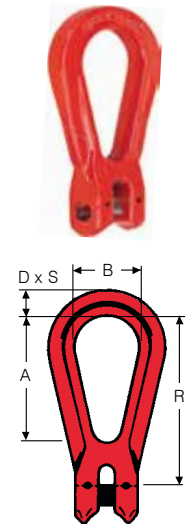

Pear Links are commonly used in choking applications.

- Traditional Kuplex flat section material.
- Complies with EN1677.
- Design factor 4:1.
- Manufactured in the U.K.



Example of Use:
Single Leg Reeveable Collar Chain Sling.

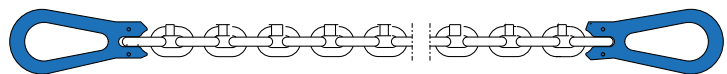

• When choked, the sling Working Load Limit must be reduced by 20%.



• Never exceed manufacturer's Working Load Limit (WLL).

CONNECTORS

Connecting Link – Type X-015



Product Code	Yoke Item No.	WLL	G100 Chain	Dimensions (mm)				Weight
		t	mm	A	B	D	K	kg
02459707	X-015-07	2.5	7, 8	18	25	9	59	0.2
02459710	X-015-10	4.0	10	25	28	11	69	0.3
02459713	X-015-13	6.7	13	30	38	16	92	0.7
02459716	X-015-16	10.0	16	36	41	19	101	1.2
02459719	X-015-20	16.0	20	42	50	23	122	2.1
02459722	X-015-22	19.0	22	49	63	24	152	3.5
02459726	X-015-26	26.5	26	55	66	30	162	4.8

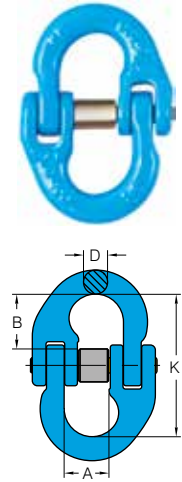

Provides a fast and safe means of assembling, dismantling and reassembling chain slings.

- Design factor 4:1 proof tested and certified.
- Manufactured in Taiwan.

Spare Pin & Sleeve Set – to Suit Type X-015



Product Code	Yoke Item No.	Suits Yoke Connectors
		Product Code
02459807	X-P015-07	02459707
02459810	X-P015-10	02459710
02459813	X-P015-13	02459713
02459816	X-P015-16	02459716
02459819	X-P015-20	02459719
02459822	X-P015-22	02459722
02459826	X-P015-26	02459726



- Manufactured in Taiwan.



- Never exceed manufacturer's Working Load Limit (WLL).
- Safe Use: Each connector body half should not have in use more than one load bearing component or chain.
- Avoid over-crowding to ensure load will be transmitted axially.

GRADE 100

CONNECTORS

Kupler Connecting Link – Type K



Product Code	KUPLEX Item No.	WLL	Suit Chain	Dimensions (mm)				Weight
		t	Ø (mm)	R	W	D	S	kg
02403907	K7N	2.0	7	60	26	12	10	0.15
02403910	K10N	4.0	10	73	35	19	15	0.47
02403913	K13N	6.7	13	95	45	25	22	1.01
02403916	K16N	10.0	16	118	54	28	23	1.66
02403919	K19N	14.0	19	134	64	34	28	2.78
02403923	K23N	21.0	23	121	64	45	38	4.26
02403926	K26	27.0	26	140	82	48	45	6.30
02403932	K32	40.0	32	175	96	64	51	11.48

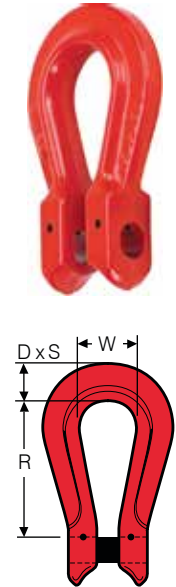

This component is used for joining chain to KM Master Links or to KMML Litalinks.

- Complies with EN1677.
- 4:1 design factor.
- Manufactured in the U.K.



Kuplex® Kupler Connecting Links can be used to connect chains to KM Master Links or KMML Litalinks in various sling configurations.



• Never exceed manufacturer's Working Load Limit (WLL).

GRADE 100

SHORTENING CLUTCHES

Shortening Clutches enable a multi-leg chain sling to have different leg lengths as required to adjust to the balance or required lifting angle of the load. Cookes offer several styles of shortening clutch to meet users preferences.

Shortening Clutch – Type KSCN

Crosby® Kuplex®

Product Code	KUPLEX Item No.	WLL	Suit Chain	Dimensions (mm)			Weight kg
		t	Ø (mm)	L	R	A	
02411907	KSC7N	2.0	7	161	60	26	0.53
02411910	KSC10N	4.0	10	211	73	36	1.28
02411913	KSC13N	6.7	13	272	95	46	2.70
02411916	KSC16N	10.0	16	360	118	56	5.26
02411919	KSC19N	14.0	19	427	134	68	9.87

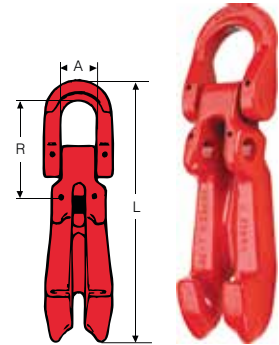

This unique component for leg length adjustment is a major feature of the KUPLEX system. It caters for loads of irregular shape or for a general lack of headroom and allows safe leg length adjustment of any number of legs with the load remaining fully in line.

- Complies with EN1677.
- 4:1 design factor.
- Manufactured in the U.K.

Shortening Clutch – Type KSC

Crosby® Kuplex®

Product Code	KUPLEX Item No.	WLL	Suit Chain	Dimensions (mm)		Weight kg
		t	Ø (mm)	L	A	
02411023	KSC23	21	23	308	190	10.02
02411026	KSC26	27	26	360	226	15.39

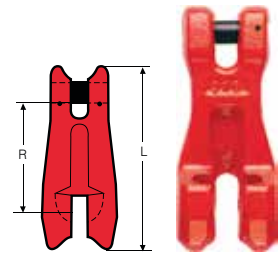

Performs a function similar to that of KSCN, but requires separate suspension on the master link or multi-oblong link using a connector and three links of chain.

- Complies with EN1677.
- 4:1 design factor.
- Manufactured in the U.K.



The correct use of KUPLEX Shortening Clutches:



KSCN Shortening Clutch in use.



KSC Shortening Clutch in use.
Basket configuration.

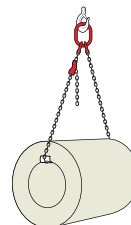

- Note that the loaded end of the chain must come out of the bottom of the clutch.



Use of Clevis Grab Hooks for shortening

- Grade 100 cradle type Grab Hooks with supporting wings may also be used as chain leg shortening devices with no derating of WLL. For specifications refer page 61.



- Never exceed manufacturer's Working Load Limit (WLL).

HOOKS

Choosing the correct lifting hook.

The hook is a crucial element in ensuring safe lifting, therefore always give careful consideration to the type of lift, the shape of the load, and then select the hook best suited to the application.



Self Locking Hooks

May also be referred to as 'Safety Locking Hooks' or 'Latchlok Hooks'. Self locking hooks are designed to pivot in the middle and lock once the load is applied. It requires pressure on the trigger to release the hook when the load is grounded. The hook pivots fully open to give unrestricted access to the hook bowl. Always ensure the load is supported in the bowl of the hook.



Swivel Self Locking Hooks

Same operation as the conventional self locking hook but incorporates a bow and swivel assembly. Where the swivel action is required only to position a load choose a plain bearing model. When the swivel is required to rotate under load choose only a ball bearing model. Always ensure the load is supported in the bowl of the hook.



Safety Handle Self-Locking Hooks

A self-locking hook with added safety handle designed to eliminate the serious pinch and hand-trap hazards associated with traditional lifting hooks. Available as a standard eye type hook or with swivel top.



Sling Hooks

May also be referred to as 'Slip Hooks'. The sling hook was for many years the standard choice for lifting chains. It has been overtaken in popularity to some extent by the self locking hook but still remains very popular today. Always ensure the load is supported in the bowl of the hook and that the safety latch is engaged.

HOOKS

Choosing the correct lifting hook.

The hook is a crucial element in ensuring safe lifting therefore always give careful consideration to the type of lift, the shape of the load, and then select the hook best suited to the application.



Grab Hooks

May also be referred to as a 'Snig Hook'. The narrow throat of a grab hook allows one link of chain to be seated and effectively grabbed. Grab hooks may be used to choke a load or are commonly used for shortening of chain legs. Always insist on the cradle type grab hook with supporting wings. Where used as a shortening device cradle type grab hooks maintain their full WLL. When cradle type grab hooks are used as bottom hooks for choking purposes, the sling WLL must be derated by 20%.



Foundry Hooks

Designed with a wide throat, these hooks are ideal for unusually bulky attachment points. Foundry hooks do not incorporate a safety latch. Under the Approved Code of Practice for Load Lifting Rigging, such hooks may only be used where fitting and removing of a load cannot be physically achieved with a hook incorporating a safety latch. It is the user's responsibility to ensure that a foundry hook is safe for the intended application and meets the requirements of the Code. Always ensure the load is supported in the bowl of the hook.



C Hooks

This style of hook has a projection over the hook tip intended to stave off obstructions which might otherwise foul the hook tip during lifting. C Hooks do not incorporate a safety latch. Under the Approved Code of Practice for Load Lifting Rigging, such hooks may only be used where fitting and removing of a load cannot be physically achieved with a hook incorporating a safety latch. Always ensure the load is supported in the bowl of the hook.

Safety Latches



- As detailed in the Approved Code of Practice for Load-Lifting Rigging (5th edition 2012): "Safety latches are to be fitted to hooks unless fitting and removal of the load cannot be physically achieved with a latch fitted, for example: using a molten metal pouring ladle in a steel works".

HOOKS

Clevis Self-Locking Hook – Type X-026



Product Code	Yoke Item No.	WLL	G100 Chain	Dimensions (mm)					Weight
		t	mm	A	H	K	P	T	kg
02461707	X-026-07	2.5	7, 8	9	24	119	34	20	0.9
02461710	X-026-10	4.0	10	11	30	142	44	26	1.4
02461713	X-026-13	6.7	13	14	39	178	51	30	3.0
02461716	X-026-16	10.0	16	18	49	213	60	36	5.0
02461719	X-026-20	16.0	20	21	65	244	70	53	11.0
02461722	X-026-22	19.0	22	24	63	273	80	49	13.5

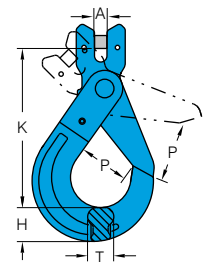

Designed so the latch cannot open under load and requires pressure on the trigger to release the hook when the load is grounded.

- Latch trigger on rear of hook.
- Design factor 4:1 proof tested and certified.
- Replacement trigger kits available.
- Manufactured in Taiwan.

Clevis Self Locking Hook – Type KHXC



Product Code	KUPLEX Item No.	WLL	G100 Chain	Dimensions (mm)				Weight
		t	mm	R	D	S	T	kg
02417907	KHX7C	2.0	7	117	25	19	36	0.82
02417910	KHX10C	4.0	10	146	32	24	47	1.51
02417913	KHX13C	6.7	13	181	42	30	56	3.15
02417916	KHX16C	10.0	16	223	49	36	70	5.27

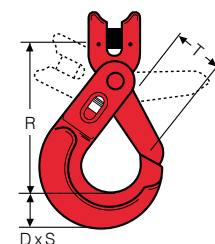

Designed so the latch cannot open under load and requires pressure on the trigger to release the hook when the load is grounded.

- Latch trigger on side of hook.
- Complies with EN1677.
- 4:1 design factor.
- Replacement trigger kits available.
- Manufactured in the U.K.



- Yoke Self-Locking Hooks have the latch trigger on the rear of hook.
- Kuplex® Self-Locking Hooks have the latch trigger on the side of hook as illustrated above.



- Never exceed manufacturer's Working Load Limit (WLL).

HOOKS

Eye Self Locking Hook – Type KHXE

Grosby  Kuplex

Product Code	KUPLEX Item No.	WLL	G100 Chain	Dimensions (mm)					Weight
		t	mm	R	D	S	T	E Ø	kg
02417507	KHX7E	2.0	7	142	25	19	36	23	0.85
02417510	KHX10E	4.0	10	175	32	24	47	30	1.15
02417513	KHX13E	6.7	13	217	42	32	56	40	3.06
02417516	KHX16E	10.0	16	272	49	36	70	51	5.24
02417519*	KHX19E	14.0	19	277	66	53	80	65	9.50
02417523*	KHX23E	21.0	23	315	69	63	92	75	13.90

* Available on indent.

Designed so the latch cannot open under load and requires pressure on the trigger to release the hook when the load is grounded.

- Latch trigger on side of hook.
- Complies with EN1677.
- 4:1 design factor.
- Replacement trigger kits available.
- Manufactured in the U.K.

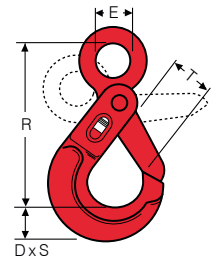

• Never exceed manufacturer's Working Load Limit (WLL).

HOOKS

Eye Swivel Self Locking Hook – Type X-027N (Ball Bearing)



Product Code	KUPLEX Item No.	WLL	G100 Chain	Dimensions (mm)							Weight
		t	mm	A	B	D	H	K	P	T	kg
02462707N	X-027N-07	2.5	7, 8	36	29	13	24	186	34	20	1.3
02462710N	X-027N-10	4.0	10	41	34	16	30	218	44	26	2.0
02462713N	X-027N-13	6.7	13	46	43	21	39	276	51	30	4.3
02462716N	X-027N-16	10.0	16	61	50	23	49	329	60	36	7.3
02462719N	X-027N-20	16.0	20	74	82	25	65	387	70	53	13.0
02462722N	X-027N-22	19.0	22	97	95	33	63	457	80	49	20.0
02462726N	X-027N-26	26.5	26	123	115	42	69	535	99	56	32.7

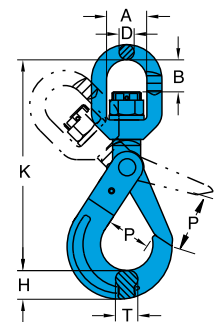

Designed so the latch cannot open under load and requires pressure on the trigger to release the hook when the load is grounded. With Ball Bearing, which allows swivel to operate under load.

- Latch trigger at rear of hook.
- Design factor 4:1 proof tested and certified.
- Replacement trigger kits available.
- Manufactured in Taiwan.

Eye Swivel Self Locking Hook – Type KHXS (Plain Bearing)



Product Code	KUPLEX Item No.	WLL	G100 Chain	Dimensions (mm)							Weight
		t	mm	A	B	R	D	S	T	C Ø	kg
02417007	KHX7S	2.0	7	42	42	202	25	19	36	12	1.24
02417010	KHX10S	4.0	10	50	46	235	32	24	47	15	2.11
02417013	KHX13S	6.7	13	60	62	293	42	30	56	19	4.28

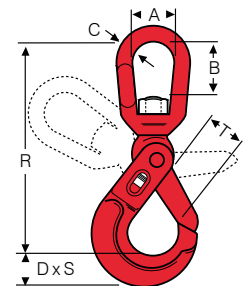

Designed so the latch cannot open under load and requires pressure on the trigger to release the hook when the load is grounded. With plain bearing for load positioning applications.

- Plain Bearing.
- Latch trigger on side of hook.
- Complies with EN1677.
- 4:1 design factor.
- Replacement trigger kits available.
- Manufactured in the U.K.



- Never exceed manufacturer's Working Load Limit (WLL).
- The KHXS hook is a positioning device & is not intended to rotate under load.

HOOKS

Eye Self Locking Safety Handle Hook



Product Code	Nautilus Item No.	WLL	Chain Size	Dimensions (mm)				Weight
		t	mm	L	H	W	O	kg
02445004E	NH-SL4E	4.0	10	216	32	156	47	2.6

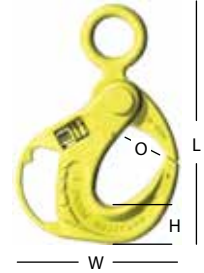

Eye Swivel Self Locking Safety Handle Hook



Product Code	Nautilus Item No.	WLL	Chain Size	Dimensions (mm)				Weight
		t	mm	L	H	W	O	kg
02445004S	NH-SL4S	4.0	10	242	32	156	47	3.1



NAUTILUS™ HOOKS PROVIDE THE ULTIMATE SAFETY IN SELF-LOCKING LIFTING HOOKS.

- The safety features provide a unique and very simple operation.
- The integral handle protects operators' hands and removes them from the hook and sling interface area.
- Manufactured from high-grade carbon alloy steel.
- Corrosion-resistant stainless steel spring.
- Complies with EN1677.
- 4:1 design factor.
- Manufactured in the U.K.

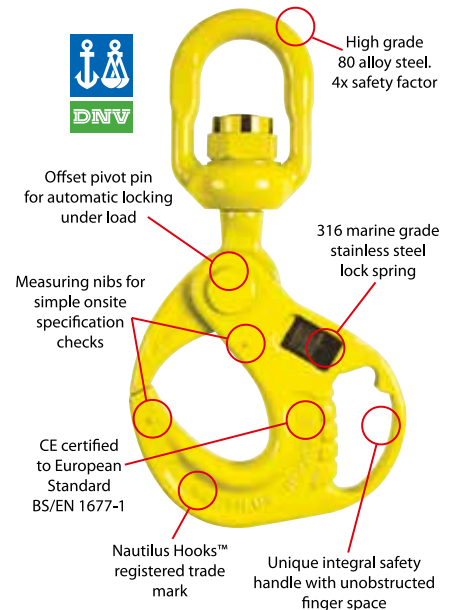

- Self-locking safety hooks with features which eliminate the risk of potentially serious pinch and trap hand injuries often associated with the use of traditional 'self-locking' hooks.



- Never exceed manufacturer's Working Load Limit (WLL).
- The Nautilus Safety Handle Hooks are positioning devices and are not intended to rotate under load.

HOOKS

Clevis Sling Hook – Type X-043/S



Product Code	Yoke Item No.	WLL	G100 Chain	Dimensions (mm)					Weight
		t	mm	A	H	K	P1	T	kg
02472707	X-043/S-07	2.5	7, 8	9	22	98	27	18	0.6
02472710	X-043/S-10	4.0	10	11	30	122	34	24	1.1
02472713	X-043/S-13	6.7	13	14	37	147	44	30	2.3
02472716	X-043/S-16	10.0	16	17	42	166	48	39	3.8
02472719	X-043/S-20	16.0	20	24	64	207	57	48	8.7
02472722	X-043/S-22	19.0	22	25	61	217	73	52	9.5

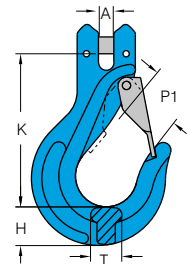

- Includes safety latch.
- Replacement safety latches available.
- Design factor 4:1 proof tested and certified.
- Manufactured in Taiwan.

Clevis Sling Hook – Type KH & KHN



Product Code	KUPLEX Item No.	WLL	Dimensions (mm)				Weight
		t	R	D	S	T	kg
02405607	KHN7L	2.0	75	26	19	21.5	0.42
02405610	KHN10L	4.0	107	37	27	31.0	1.10
02405613	KHN13L	6.7	139	48	36	40.0	2.60
02405616	KHN16L	10.0	171	59	43	53.5	4.41
02405619	KHN19L	14.0	203	70	50	62.0	7.81
02405623*	KH23	21.0	222	79	51	60.0	13.14
02405626*	KH26	27.0	251	89	60	72.0	18.94
02405632	KHN32L	40.0	334	118	85	106.0	34.61

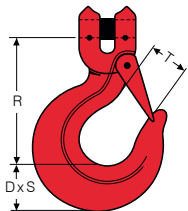

* Supplied without safety latch as standard.

- Safety latches available for all sizes (must be purchased separately for models KH23 and KH26).
- 4:1 design factor.
- Manufactured in the U.K.



• Never exceed manufacturer's Working Load Limit (WLL).

HOOKS

Clevis Wide Bowl Sling Hook – Type KHWN

Grosby  Kuplex

Product Code	KUPLEX Item No.	WLL	Dimensions (mm)					Weight
		t	R	D	S	T no Latch	T w/ Latch	kg
02438007	KHW7N	2.0	95	29	21	37	32	0.7
02438010	KHW10N	4.0	130	42	30	48	44	1.9
02438013	KHW13N	6.7	168	52	38	66	59	4.0
02438016	KHW16N	10.0	208	65	48	79	74	7.1

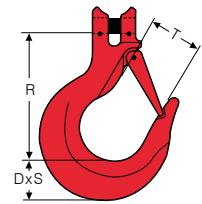

Designed with a more generous throat opening and bowl than conventional sling hooks.

- Includes safety latch.
- Replacement safety latches available.
- 4:1 design factor.
- Manufactured in the U.K.

Eye Sling Hook – Type X-044/S

YOKE

Product Code	Yoke Item No.	WLL	G100 Chain	Dimensions (mm)						Weight
		t	mm	A	D	H	K	P1	T	kg
02472726E	X-044/S-26	26.5	26	65	35	80	279	77	60	13.5
02472732E	X-044/S-32	40.0	32	88	40	86	352	114	65	22.0

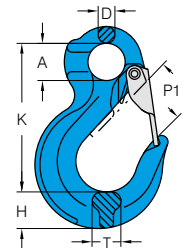

- Includes safety latch.
- Replacement safety latches available.
- Design factor 4:1 proof tested and certified.
- Manufactured in Taiwan.



• Eye Sling Hooks are suitable for use on both lifting slings and winch cables.



• Never exceed manufacturer's Working Load Limit (WLL).

GRADE 100

HOOKS

Clevis Grab Hook – Type X-042



Product Code	Yoke Item No.	WLL	G100 Chain	Dimensions (mm)				Weight
		t	mm	A	H	K	P	kg
02467707	X-042-07	2.5	7, 8	10	22	54	10	0.4
02467710	X-042-10	4.0	10	11	29	77	13	0.8
02467713	X-042-13	6.7	13	15	38	99	17	1.6
02467716	X-042-16	10.0	16	18	45	114	21	2.7
02467719	X-042-20	16.0	20	22	52	130	23	4.8
02467722	X-042-22	19.0	22	24	56	139	26	6.4

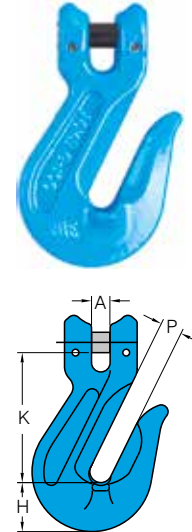

Supporting wings prevent chain link deformation. No reduction in WLL when used as a shortening device.

- Design factor 4:1 proof tested and certified.
- Manufactured in Taiwan.

Eye Grab Hook – Type X-041



Product Code	Yoke Item No.	WLL	G100 Chain	Dimensions (mm)			Weight
		t	mm	A	K	P	kg
02467726E	X-041-26	26.5	26	50	207	33	10.1

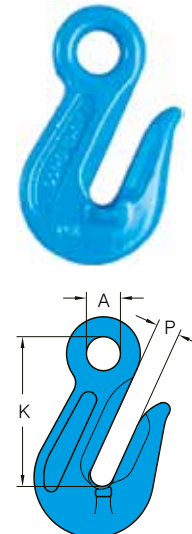

Supporting wings prevent chain link deformation. No reduction in WLL when used as a shortening device.

- Design factor 4:1 proof tested and certified.
- Use Yoke connector 02459726 (page 50) for chain connection.
- Manufactured in Taiwan.

• Where grab hooks are fitted as bottom hooks or chain is choked, the sling WLL must be derated by 20%.

• Never exceed manufacturer's Working Load Limit (WLL).

HOOKS

Clevis Foundry Hook – Type KF

Grosby  Kuplex

Product Code	KUPLEX Item No.	WLL	Dimensions (mm)				Weight
		t	R	D	S	T	kg
02407907	KF7N	2.0	118	24	22	64	0.79
02407910	KF10N	4.0	137	32	30	76	1.74
02407913	KF13N	6.7	165	41	38	89	3.45
02407916*	KF16N	10.0	222	52	48	114	7.40
02407919*	KF19N	14.0	248	61	56	127	11.82
02407923*	KF23N	21.0	280	78	64	140	20.30

* These sizes available on indent only.

Designed with wide throat.

- 4:1 design factor.
- Complies with EN1677.
- Manufactured in the U.K.

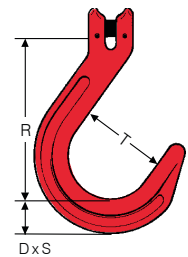

Clevis C Hook – Type KC

Grosby  Kuplex

Product Code	KUPLEX Item No.	WLL	Dimensions (mm)				Weight
		t	R	D	S	T	kg
02408907	KC7N	2.0	90	27	19	20	0.45
02408910	KC10N	4.0	127	38	27	28	1.26
02408913	KC13N	6.7	165	49	36	39	2.78
02408916*	KC16N	10.0	203	60	43	45	5.16
02408919*	KC19N	14.0	242	71	52	55	8.83

* These sizes available on indent only.

The profile of this hook is designed to prevent fouling of the tip of the hook on obstructions such as scaffolding.

- 4:1 design factor.
- Complies with EN1677.
- Manufactured in the U.K.

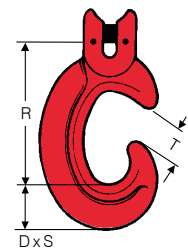

• Never exceed manufacturer's working load limit (WLL).



• Foundry Hooks and C Hooks do not include a safety latch and may only be used where fitting and removing of a load cannot be physically achieved with a hook incorporating a safety latch.

TRIGGER KITS & SAFETY LATCH KITS

Replacement Trigger Kits for Self Locking Hooks



Product Code	Yoke Item No.	Suits Yoke G100 Hook Types	Size
			mm
02461507	8-P025-07	X-026, X-027N	7 – 8
02461510	8-P025-10	X-026, X-027N	10
02461513	8-P025-13	X-026, X-027N	13
02461516	8-P025-16	X-026, X-027N	16
02461519	8-P025-20	X-026, X-027N	20
02461522	8-P025-22	X-026, X-027N	22
02461526	8-P025-26	X-026, X-027N	26



Kit Designed for use with both, Grade 80 and Grade 100 Yoke Self Locking Hooks.

- Manufactured in Taiwan.

Replacement Safety Latch Kits for Sling Hooks



Product Code	Yoke Item No.	Suits Yoke G100 Hook Types	Size
			mm
02472507	8-P044-07	X-043/S, X-044/S,	7 – 8
02472510	8-P044-10	X-043/S, X-044/S,	10
02472513	8-P044-13	X-043/S, X-044/S,	13
02472516	8-P044-16	X-043/S, X-044/S,	16
02472519	8-P044-20	X-043/S, X-044/S,	20
02472522	8-P044-22	X-043/S, X-044/S,	22
02472526	8-P044-26	X-043/S, X-044/S,	26
02472532	8-P044-32	X-043/S, X-044/S,	32



Kit Designed for use with both, Grade 80 and Grade 100 Yoke Sling Hooks.

- Manufactured in Taiwan.

TRIGGER KITS & SAFETY LATCH KITS

Trigger Kits for Kuplex® Self Locking Hooks

Grosby® Kuplex®

Product Code	Kuplex Item No.	Suits Kuplex Hook Types	Size
			mm
02405207	KHX Trigger – 7	KHXC, KHXE, KHXS	7
02405210	KHX Trigger – 10	KHXC, KHXE, KHXS	10
02405213	KHX Trigger – 13	KHXC, KHXE, KHXS	13
02405216	KHX Trigger – 16	KHXC, KHXE, KHXS	16



Safety Latch – Type KHLN

Grosby® Kuplex®

Product Code	Kuplex Item No.	Suits Kuplex Sling Hook Product Code	Size
			mm
02418907	KHL7N	02405607	7
02418910	KHL10N	02405610	10
02418913	KHL13N	02405613	13
02418916	KHL16N	02405616	16
02418919	KHL19N	02405619	19



Hook Latch Assembly – Type KHL

Grosby® Kuplex®

Product Code	Kuplex Item No.	Suits Kuplex Sling Hook Product Code	Size
			mm
02418923	KHL23	02405623	23
02418926	KHL26	02405626	26



Includes a load pin to which the latch is attached.

Safety Latch – Type KHWL

Grosby® Kuplex®

Product Code	Kuplex Item No.	Suits Kuplex Wide Bowl Sling Hook Product Code	Size
			mm
02418902	KHWL7	02438007	7
02418903	KHWL10	02438010	10
02418904	KHWL13	02438013	13
02418905	KHWL16	02438016	16



- All Kuplex® trigger kits and safety latch kits manufactured in the U.K.

GRADE 100

CLEVIS SHACKLES

Clevis Shackle – Type X-066



Product Code	Yoke Item No.	WLL	G100 Chain	Dimensions (mm)						Weight kg
		t	mm	A	C	K	L	M	W	
02478707	X-066-07	2.5	7 – 8	9	79	59	35	16	33	0.4
02478710	X-066-10	4.0	10	11	93	78	48	20	37	0.8
02478713	X-066-13	6.7	13	14	118	98	64	22	49	1.4
02478716	X-066-16	10.0	16	18	141	112	69	28	60	2.5

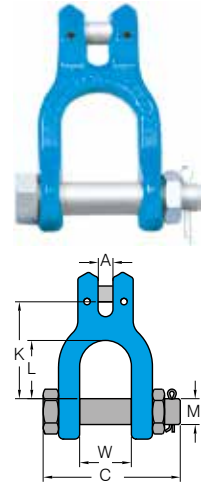

Clevis end connects directly to chain.

- Design factor 4:1 proof tested and certified.
- Manufactured in Taiwan.

Clevis Wide Jaw Shackle – Type KDL



Product Code	KUPLEX Item No.	WLL	G100 Chain	Dimensions (mm)					Weight kg
		t	mm	A	B	C	R	D	
02412907	KDL7N	2.0	7	48	65	35	71	19	0.71
02412910	KDL10N	4.0	10	74	83	44	104	22	1.36
02412913	KDL13N	6.7	13	98	109	57	136	29	3.02
02412916	KDL16N	10.0	16	122	140	73	173	35	6.18
02412919	KDL19N	14.0	19	145	162	86	203	44	10.62

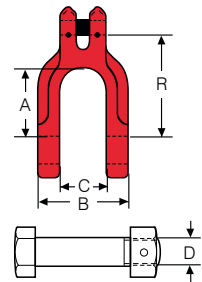

Has a wide jaw and attaches directly to the chain.

- Complete with bolt, hexagon nut and cotter pin.
- 4:1 design factor.
- Manufactured in the U.K.

Clevis Narrow Jaw Shackle – Type KDN



Product Code	KUPLEX Item No.	WLL	G100 Chain	Dimensions (mm)					Weight kg
		t	mm	A	B	C	R	D	
02412507	KDN7N	2.0	7	36	42	20	57	14	0.26
02412510	KDN10N	4.0	10	53	58	28	83	20	0.85
02412513	KDN13N	6.7	13	72	74	35	106	24	1.68
02412516	KDN16N	10.0	16	83	90	44	127	30	3.14

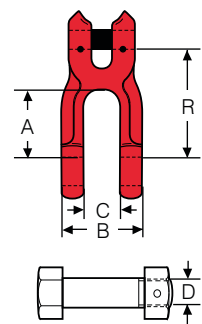

Has a narrow jaw and attaches directly to the chain.

- Complete with bolt, hexagon nut and cotter pin.
- 4:1 design factor.
- Manufactured in the U.K.

- Clevis Shackles negate the requirement for a separate shackle to be used.
- Perfect for connecting chain slings to the likes of plate lifting clamps.
- Grade 80 Clevis Shackles are also available, refer page 38.

- Never exceed manufacturer's Working Load Limit (WLL).

LOAD PIN KITS

Load Pins



Product Code	Kuplex Item No.	Suits Kuplex Clevis Component Types	Size
			mm
02416007	KP7	K, KC, KF, KS, KSS, KDL, KDN, KHN, KHX, KHWN	7
02416010	KP10	K, KC, KF, KS, KSS, KDL, KDN, KHN, KHX, KHWN	10
02416013	KP13	K, KC, KF, KS, KSS, KDL, KDN, KHN, KHX, KHWN	13
02416016	KP16	K, KC, KF, KS, KSS, KDL, KDN, KHN, KHX, KHWN	16
02416019	KP19	K, KC, KF, KS, KSS, KDL, KDN, KHN, KHX, KHWN	19
02416023	KP23	K, KC, KF, KS, KSS, KDL, KDN, KHN, KHX, KHWN	23
02416026	KP26	K, KC, KF, KS, KSS, KDL, KDN, KHN, KHX, KHWN	26
02416032	KP32	K, KC, KF, KS, KSS, KDL, KDN, KHN, KHX, KHWN	32



- Manufactured in the UK.

Retainer Pins



Product Code	Kuplex Item No.	Suits Kuplex Clevis Component Types	Size
			mm
02415007	KR7	K, KC, KF, KS, KSS, KDL, KDN, KHN, KHX, KHWN	7
02415010	KR10	K, KC, KF, KS, KSS, KDL, KDN, KHN, KHX, KHWN	10
02415013	KR13	K, KC, KF, KS, KSS, KDL, KDN, KHN, KHX, KHWN	13
02415016	KR16	K, KC, KF, KS, KSS, KDL, KDN, KHN, KHX, KHWN	16
02415019	KR19	K, KC, KF, KS, KSS, KDL, KDN, KHN, KHX, KHWN	19
02415023	KR23	K, KC, KF, KS, KSS, KDL, KDN, KHN, KHX, KHWN	23
02415026	KR26	K, KC, KF, KS, KSS, KDL, KDN, KHN, KHX, KHWN	26
02415032	KR32	K, KC, KF, KS, KSS, KDL, KDN, KHN, KHX, KHWN	32



- Manufactured in the UK.



• Cookes recommends that Load Pins and Retaining Pins are replaced whenever clevis components are refitted.



• For use with specified Kuplex components only.

GRADE 100

LOAD PIN KITS

Load Pin & Retainer Pin Sets



Product Code	Yoke Item No.	Suits Yoke Clevis Component Types	Size
			mm
02474507	X-P026-07	X-026, X-042, X-043/S, X-059, X-066	7
02474510	X-P026-10	X-026, X-042, X-043/S, X-059, X-066	10
02474513	X-P026-13	X-026, X-042, X-043/S, X-059, X-066	13
02474516	X-P026-16	X-026, X-042, X-043/S, X-059, X-066	16
02474520	X-P026-20	X-026, X-042, X-043/S, X-059, X-066	20
02474522	X-P026-22	X-026, X-042, X-043/S, X-059, X-066	22



- Manufactured in Taiwan.



• Cookes recommends that Load Pins and Retaining Pins are replaced whenever clevis components are refitted.



• For use with specified Yoke components only.

CARE & USE OF CHAIN SLINGS

CHAIN SLING EXAMPLES

Single Leg

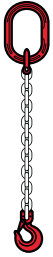

With Kuplink
and sling hook

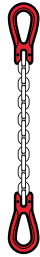

Collar sling
with pear link
each end

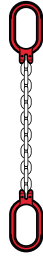

Collar sling
with Kuplink
each end

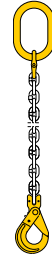

With master
link and self
locking hook



With pear link and
self locking hook

Double Leg



With master link
and sling hooks

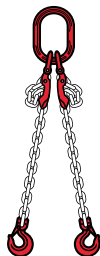

With master link,
shortening clutches
and sling hooks



With master link, grab
hook shortener and
self locking hooks

Three Leg

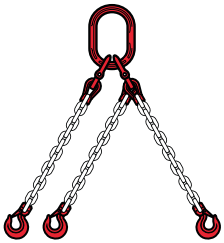

With multi-link assembly
and sling hooks



With multi-link assembly,
shortening clutches and
sling hooks

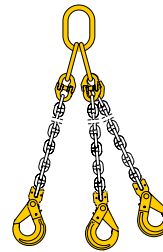

With multi-link assembly
and self locking hooks

Four Leg



With multi-link assembly
and sling hooks



With multi-link assembly,
shortening clutches and
sling hooks

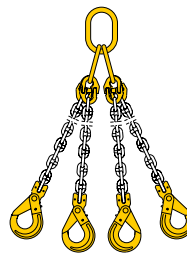

With multi-link assembly
and self locking hooks

Endless

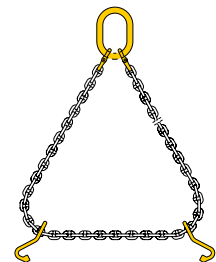

With master link and
sliding drum hooks

Images courtesy of Crosby Group and Yoke Industrial

CARE & USE OF CHAIN SLINGS

MULTI-LEG CHAIN SLING LEG ANGLES

Example showing effect that change of angle has on chain sling leg loading

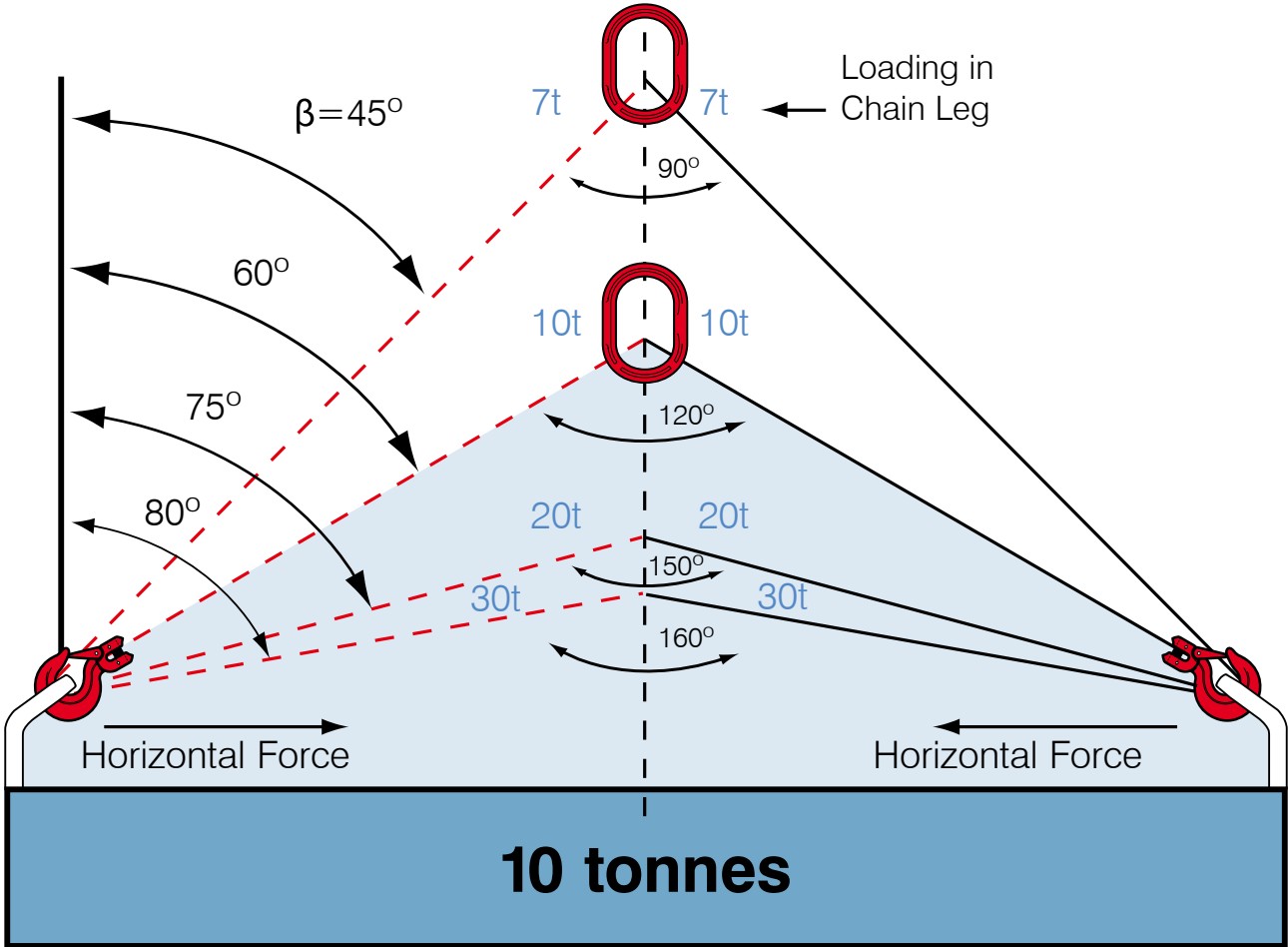

Do Not Use Multi-Leg Chain Slings at Angles Within the Shaded Area.

- Multi-leg chain slings exert a horizontal component of force which increases as the included angle becomes greater.
- Do not use chain slings if the included angle between the legs exceeds 120° . Beyond this point the forces in the legs increase dramatically as illustrated in the example above.
- Do not use chain slings if the included angle between the legs is less than 60° as this can lead to load becoming unstable.

Additional information is also available in the LEENZ Code of Practice for the Safe Use of Lifting Equipment. Copies may be purchased from Cookes under item code 02000035.



• For additional advice on safe lifting, please contact your local Cookes branch, Freephone 0508 274 366 or email customerservices@bridoncookes.co.nz.



Spreader Beams

A spreader beam helps to distribute the load across more than one point. This increases stability and decreases the loads applied during hoisting.

View the range of Maxirig spreader beams in the Materials Handling section of this catalogue.



• Danger: Overhead lifting presents a very real danger of severe injuries or loss of life if lifting equipment is not used properly.

CARE & USE OF CHAIN SLINGS

CLAMPING FORCE

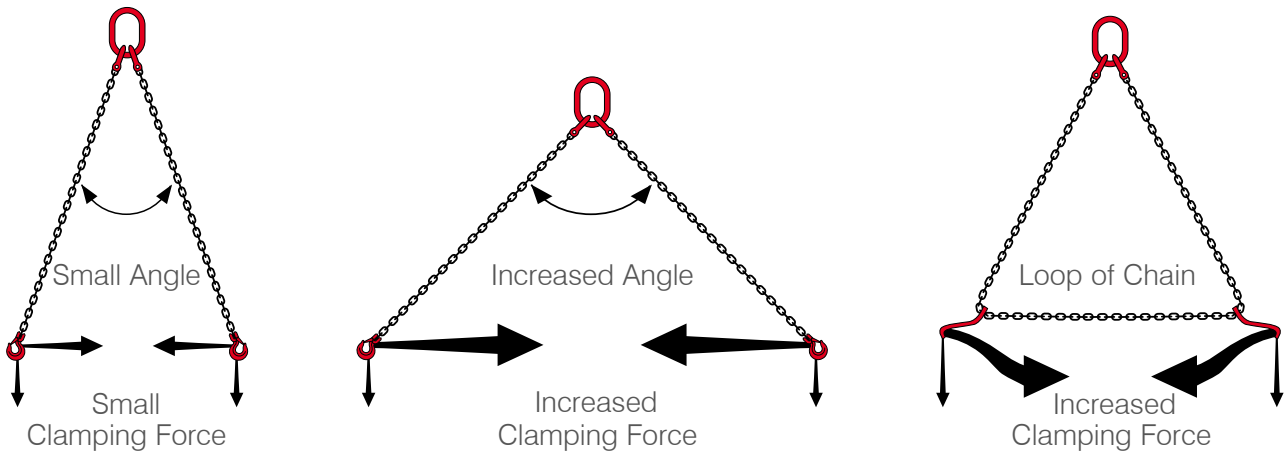

Multi-leg slings impact a 'clamping force' or a compressive force on the load which increases as the included angle is increased.

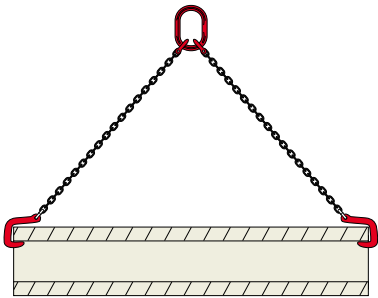

The slinger should be aware of this force so it may be used to advantage.

For example, with this shape of load, the clamping force is used to good effect in ensuring that the hooks are clamped tightly against the load.

A minimum of 60° included angle between the legs is required.

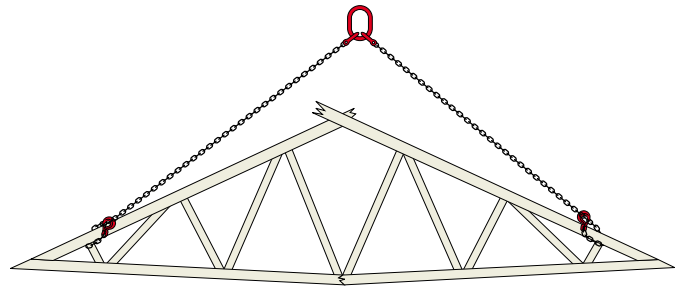

Cases have occurred where the load has not been rigid enough to withstand the clamping pressure.

Slingers should be aware of this danger and take steps to reduce the clamping force in the case of crushable loads e.g. lightweight frames.

Information provided courtesy of Crosby Kuplex



• Danger: Overhead lifting presents a very real danger of severe injuries or loss of life if lifting equipment is not used properly. Please read and understand these instructions prior to using any lifting sling assembly. Slings should only be used by competent persons responsible for the sling selection, inspection and use.

CARE & USE OF CHAIN SLINGS

G80 & G100 CHAIN SLINGS

SAFE USE

- Never load chain slings in excess of the rated capacity for the application.
- Keep a register of all slings in use.
- User should remove all twists from a chain leg before lifting and must never knot a chain.
- Always use a shortening hook or clutch when chain legs require shortening.
- Always inspect slings to ensure that chain is free from damage or wear before each use.
- Always inspect all sling components prior each use.
- Ensure that chain is protected from any sharp corners on the load.
- Ensure that the master link articulates freely on the crane hook or other lifting appliance.
- Never point load hooks. The load should always seat correctly in the bowl of the hook.
- Always use the correct size sling for the load, allowing for the included angle and the possibility of unequal loading.
- Persons must stand clear of all loads while lifting or while suspended. During lifting, personnel must be alert for possible snagging of the load or the chain sling.

MAINTENANCE

- A thorough examination must be carried out by a competent person at least every 12 months or more frequently according to statutory regulations, type and frequency of use.
- Chains with bent links or with cracks or gouges in the link should be replaced, as should deformed components such as bent master links, deformed hooks and any fittings showing signs of damage.

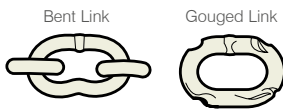

- Chain and components wear should never exceed 10% of the original dimensions.
- Once a chain sling has been overloaded it must be taken out of service.
- Store chain sling on a properly designed rack. Never leave chain slings on the floor where they may suffer mechanical or corrosion damage.
- Alloy chain slings should not be used in acid or caustic solutions nor in heavily acidic or caustic laden atmospheres. The heat treated alloy material used for alloy steel chains and components is susceptible to hydrogen embrittlement when exposed to acids.
- Chain slings must not be heat-treated, galvanised, plated, coated or subject to any process involving heating or pickling. These processes can have dangerous effects and will invalidate the manufacturer's certification.
- Alloy chain slings may be used at temperatures between -40°C to 200°C with no reduction in the Working Load Limit. The use of chain slings within the permissible temperature range in the table does not require any permanent reduction in Working Load Limit when the chain sling is returned to normal temperatures. A sling accidentally exposed to temperature in excess of the maximum permissible should be withdrawn from service immediately and returned to Cookes for thorough examination.
- When using alloy chain slings in exceptionally hazardous conditions, the degree of hazard should be assessed by a competent person and the Working Load Limit adjusted accordingly.

Sling Temperature	Reduction in WLL
-40°C – 200°C	None
200°C – 300°C	10%
300°C – 400°C	25%
Above 400°C	Do not use.



• Where professional assistance is required contact your nearest Cookes branch to have a testing technician visit.



• **Danger:** Overhead lifting presents a very real danger of severe injuries or loss of life if lifting equipment is not used properly. Please read and understand these instructions prior to using any lifting sling assembly. Slings should only be used by competent persons responsible for the sling selection, inspection and use.

CARE & USE OF CHAIN SLINGS

TOP TIPS



INSPECTIONS

Visually examine the sling before each use. Look for stretched, gouged, bent or worn links and components, including hooks with open throats, cracks or distortion. If damaged, remove from service.



SHARP EDGES

Protect chain with padding when lifting sharp edged loads.

As a general rule the radius of the edge should be greater than 2x the chain diameter.



BALANCE

Know the load. Determine the weight, centre of gravity, angle of lift and select correct size of sling.



ABRUPT MOVEMENT

Lift and lower loads smoothly. Do not jerk. Shock loading is prohibited!



OVERLOAD

Never overload the sling. Check the Working Load Limit on the identification tag. Always consider the effect of the angle of lift.

The tension of each lift is increased as the angle of lift, from horizontal, decreases. Use the chart in this catalogue for this purpose.



HIGH TEMPERATURE

Do not expose alloy chain slings to temperatures exceeding 200°C (refer chart & information on previous page).

Chain slings must not be heat-treated, galvanised or subjected to any other process involving heat.



KNOTS, TWISTS & KINKS

Make sure chain is not twisted, knotted or kinked before lifting load. Slings should never be shortened with knots, bolts or other make-shift devices.



CHAIN CARE

Store slings properly on an A-frame and protect chain slings from corrosion during storage. Do not drag slings on the floor.

'Safety Pete' Images courtesy of Peerless Chain Company.



• Where professional assistance is required contact your nearest Cookes branch to have a testing technician visit.



• Danger: Overhead lifting presents a very real danger of severe injuries or loss of life if lifting equipment is not used properly. Please read and understand these instructions prior to using any lifting sling assembly. Slings should only be used by competent persons responsible for the sling selection, inspection and use.

CARE & USE OF CHAIN SLINGS

EXAMPLES OF INCORRECT USE

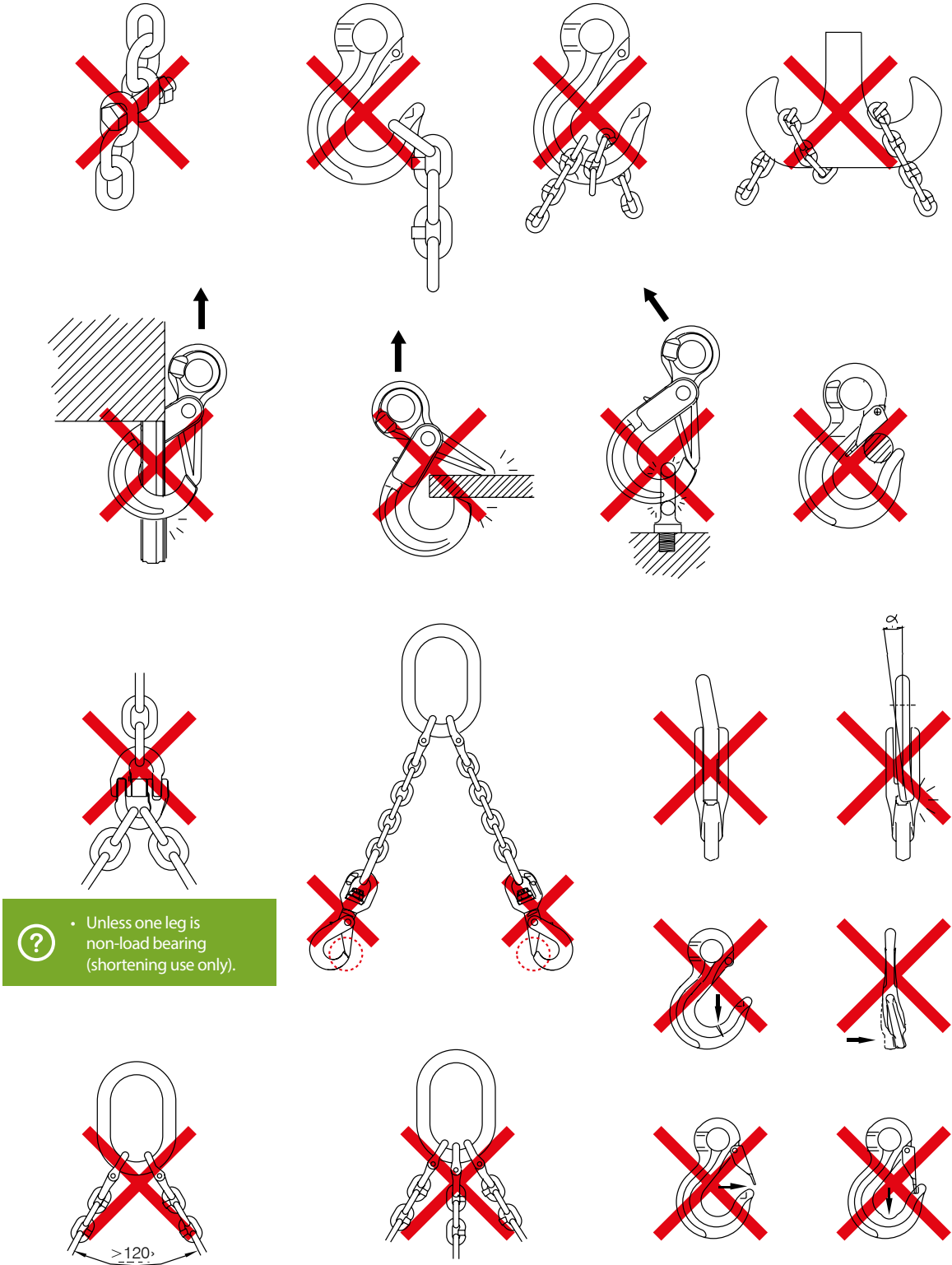

? Unless one leg is non-load bearing (shortening use only).

Images courtesy of YOKE Industrial

? Where professional assistance is required contact your nearest Cookes branch to have a testing technician visit.

STOP Danger: Overhead lifting presents a very real danger of severe injuries or loss of life if lifting equipment is not used properly. Please read and understand these instructions prior to using any lifting sling assembly. Slings should only be used by competent persons responsible for the sling selection, inspection and use.

GRADE 120

WORLD LEADING TECHNOLOGY

ICE 120 delivers improved safety features, wear indicators and higher Working Load Limits all at a full chain diameter smaller than grade 80 systems. Combined with improvements in tensioning, connecting and shortening, ICE 120 significantly reduces manual handling risks.

THE MOST SUPERIOR CHAIN AVAILABLE ON THE WORLD MARKET TODAY:

- 60% increase in WLL means the same load can be lifted by a chain one full diameter size smaller than grade 80 chain of same diameter.
- Double the impact toughness of EN818 grade 80.
- ICE Chain and components dynamically loaded to 20,000 cycles at 1.5 x WLL as per EN1677.
- Duplex surface protection provides greater protection against corrosion than hot dip galvanising.
- Corrosion tested in accordance with PAS 1061. Improved resistance to stress corrosion cracking and hydrogen embrittlement.
- Significantly increased life due to the superior CrNiMo alloy and RUD special heat treatment procedure – surface hardness (460 – 470 HV) is 28% higher than grade 80.
- Patented and specially heat treated material provides increased resistance to sharp edges.
- ICE features higher guaranteed elongation compared to grade 80 chain.
- Radio Frequency Identification System (RFID) provides full traceability throughout the life of ICE chain slings.

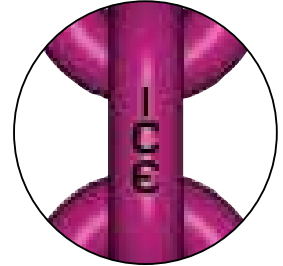

LONGER LIFE DUE TO SPECIAL HEAT TREATMENT & PATENTED MATERIAL

No matter whether it's hot or cold, when the usage is extreme, especially material handling at ports or usage at construction sites, the special RUD-ICE hardening provides many advantages.

Damage to chain caused by sharp edges is reduced thanks to RUD's patented heat treated material.

- Higher abrasion toughness.
- More insensitive towards sharp edges due to 30% better surface hardness than grade 80.
- ICE = 460 HV (Vickers Hardness Test).

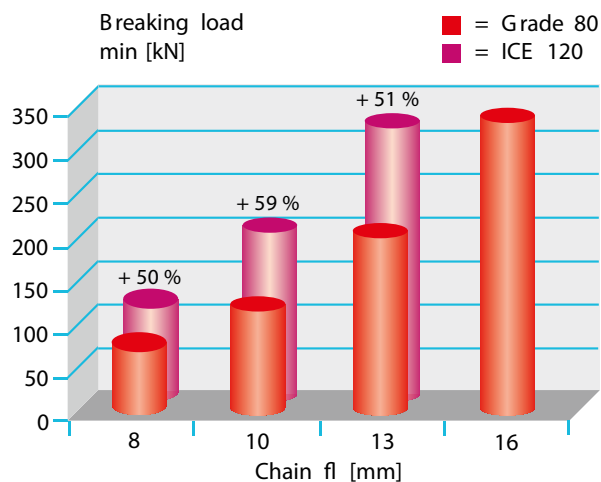
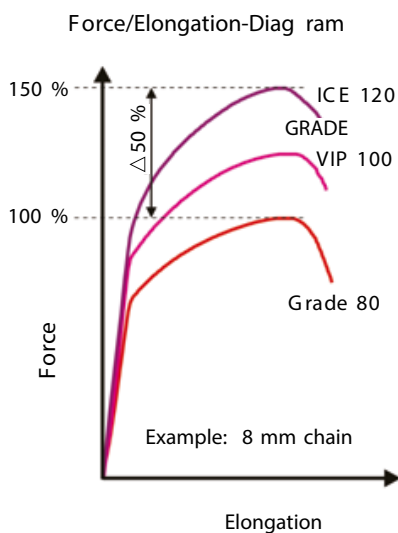

ICE 120 SLING OFFERS SIGNIFICANT WEIGHT REDUCTION

Meaning:

- Less material.
- Less energy used.
- Easier handling.
- Environmentally-friendly.
- Health and safety advantages.



CHAIN SLING WORKING LOAD LIMITS

ICE Grade 120 – Working Load Limits (WLL) in Tonnes



ICE 120	Single Leg Slings		2 Leg			3 and 4 Leg (same ratings)		
	Straight / Adj. Sling	Reeved Sling	60°	90°	120°	60°	90°	120°
Chain Ømm								
6	1.8	1.4	3.0	2.5	1.8	4.7	3.75	2.7
8	3.0	2.4	5.1	4.25	3.0	7.8	6.3	4.5
10	5.0	3.0	8.5	7.1	5.0	13.0	10.6	7.5
13	8.0	6.4	13.6	11.2	8.0	20.8	17.0	11.8
16	12.5	10.0	21.2	17.0	12.5	32.5	26.5	19.0
Load Factor >	1.00	0.80	1.7	1.4	1.0	2.6	2.1	1.5

ICE 120	2 Leg – Straight			4 Leg – Balancer	
	60°	90°	120°	$\alpha=30^\circ \beta=15^\circ$	$\alpha=60^\circ \beta=30^\circ$
Chain Ømm					
6	3.0	2.5	1.8	6.9	6.2
8	5.1	4.25	3.0	11.6	10.4
10	8.5	7.1	5.0	19.3	17.4
13	13.6	11.2	8.0	30.9	27.6
16	21.2	17.0	12.5	48.2	43.2

RUD ICE 4 Leg Balancer Slings

RUD ICE 4-leg balancer assemblies consist of two separate sling sub assemblies, Sling A and Sling B each with its own master link and identification tag.

Sling A is a conventional RUD ICE (2-leg) chain sling and may be used as such in general use application.

Sling B must only be used in conjunction with Sling A. In combination the 2 slings achieve a 4-leg assembly (specific use application) with 2 master links on a common hook for applications with a uniformly distributed load.

For conditions of use refer to User Instructions.

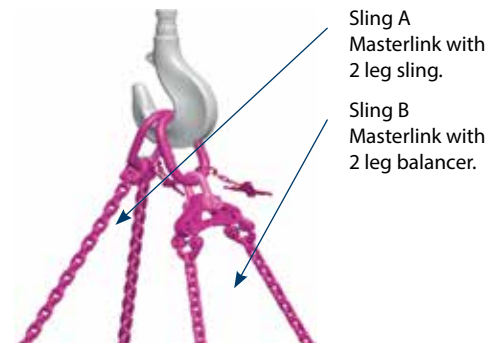

i When using two 2-leg slings with a symmetrical load distribution, one with a balancer, and both slings are attached into the same hook, four load bearing legs can be assumed. The inclination angle β must not exceed 45° (90° internal).



RUD Balancer

• Never exceed manufacturer's Working Load Limit (WLL).

LIFTING CHAIN

ICE Grade 120 Lifting Chain



Product Code	Size	WLL	Proof Load	Breaking Load	Dimensions (mm)		Weight
	Ø D	t	kN	kN	P	W1	kg / m
02398206	6	1.8	44.1	71	18	7.8	0.98
02398208	8	3.0	73.5	118	24	10.4	1.66
02398210	10	5.0	123.0	196	30	13.0	2.62
02398213*	13	8.0	196.0	314	39	17.0	4.25
02398216*	16	12.5	314.0	503	48	21.0	6.72

* Available on indent.

- Insensitive to hydrogen embrittlement.
- No reduction in elongation.
- Higher impact resistance.
- Improved surface protection.
- Stamped ICE on every link.
- Manufactured in Germany.

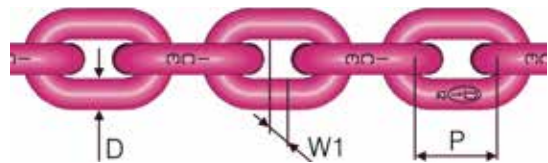

ICE >25% lighter for same WLL!



ICE 120 – 13mm
WLL 8.0t
1 Metre = 4.25kg



Grade 80 – 16mm
WLL 8.0t
1 Metre = 5.65kg

ICE-120 Always One Full Diameter
Thinner Than Grade 80!

Chain Ø mm	WLL in kg	
	Grade 80	ICE-120
6	—	1,800
8	2,000	3,000
10	3,150	5,000
13	5,300	8,000
16	8,000	12,500
20	12,500	—

ICE
120



• Never exceed manufacturer's Working Load Limit (WLL).

MASTER LINKS WITH CONNECTOR

1 Leg Slings – IAK-RG-1



Product Code	RUD Item #	WLL	Suit Chain	Dimensions (mm)				Weight
		t	mm	Ø A	B	C	T	kg ea
02398171	IAK-RG-1-6	1.8	6	13	60	110	144	0.57
02398172	IAK-RG-1-8	3.0	8	16	75	135	178	1.23
02398173	IAK-RG-1-10	5.0	10	22	90	160	213	2.19
02398174*	IAK-RG-1-13	8.0	13	26	100	180	247	3.58
02398175*	IAK-RG-1-16	12.5	16	32	140	260	343	7.20

* Available on indent.

IAK-RG type to suit DIN15401 Crane Hook sizes as per chart below.

- Includes integrated chain measuring guage.
- Manufactured in Germany.

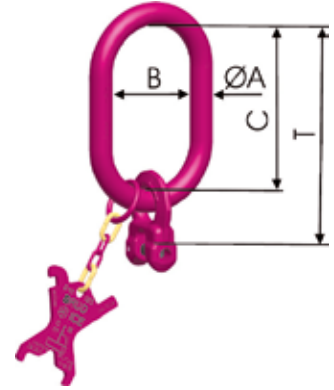

2 Leg Slings – IAK-RG-2



Product Code	RUD Item #	WLL	Suit Chain	Dimensions (mm)				Weight
		t	mm	Ø A	B	C	T	kg ea
02398181	IAK-RG-2-6	2.5	6	16	75	135	171	1.00
02398182	IAK-RG-2-8	4.25	8	22	90	160	203	2.10
02398183	IAK-RG-2-10	7.1	10	26	100	180	233	3.50
02398184*	IAK-RG-2-13	11.2	13	32	110	200	267	6.70
02398185*	IAK-RG-2-16	17.0	16	36	180	340	423	13.00

* Available on indent.

IAK-RG type to suit DIN15401 Crane Hook sizes as per chart below.

- Includes integrated chain measuring guage.
- Manufactured in Germany.

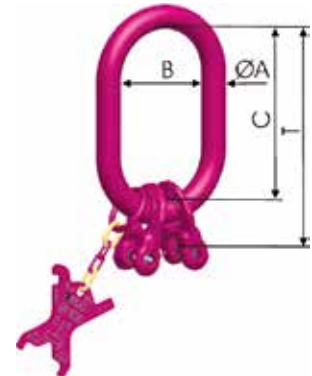

IAK-RG Suitable Up To Crane Hook Size No. (DIN15401)

RUD Item #	Size				
	6	8	20	13	16
IAK-RG 1	No. 2.5	No. 5	No. 6	No. 8	No. 16
IAK-RG 2	No. 5	No. 6	No. 8	No. 10	No. 25



• All master links shown at this page are equipped with an allside flexible clevis connector which ensures fool-proof connection in regard to the chain diameter and number of legs.



• Never exceed manufacturer's Working Load Limit (WLL).

GRADE 120

MASTER LINKS WITH CONNECTOR

3 & 4 Leg Slings – IAK-RG-4



Product Code	RUD Item #	WLL t	Chain mm	Dimensions (mm)							Weight kg ea
				Ø A	B	C	Ø D	E	F	T	
02398191	IAK-RG-4-6	3.75	6	18	90	160	13	34	70	265	2.04
02398192	IAK-RG-4-8	6.3	8	26	100	180	18	40	85	309	4.59
02398193	IAK-RG-4-10	10.6	10	32	110	200	22	50	115	369	8.37
02398194*	IAK-RG-4-13	17.0	13	36	140	260	26	65	140	467	14.44
02398195*	IAK-RG-4-16	26.5	16	46	190	350	32	75	170	603	28.87

* Available on indent.

IAK-RG type to suit DIN15401 Crane Hook sizes as per chart below.

- Includes integrated chain measuring gauge.
- Manufactured in Germany.

IAK-RG Suitable Up To Crane Hook Size No. (DIN15401)

RUD Item #	Size				
	6	8	20	13	16
IAK-RG 3&4	No. 6	No. 8	No. 10	No. 16	No. 32

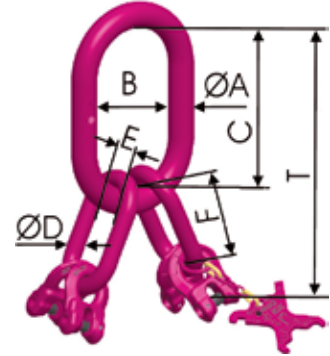

- These master links are equipped with an allside flexible clevis connector which ensures fool-proof connection in regard to the chain diameter and number of legs.
- All master links include an identification tag with integrated chain gauge.



- Never exceed manufacturer's Working Load Limit (WLL).

MASTER LINKS WITH CONNECTOR FOR LARGE CRANE HOOKS

1 Leg Slings – ISAK-RG-1



RUD Item #	WLL	Suit Chain	Dimensions (mm)							Weight
	t	mm	Ø A	B	C	Ø D	E	F	T	kg ea
ISAK-RG-1-6/140*	1.8	6	18	140	260	13	34	70	365	2.29
ISAK-RG-1-8/140*	3.0	8	22	140	260	18	40	85	389	3.94
ISAK-RG-1-10/140*	5.0	10	26	140	260	22	50	115	429	6.34
ISAK-RG-1-13/140*	8.0	13	32	140	260	26	65	140	467	9.44
ISAK-RG-1-6/190*	1.8	6	22	190	350	13	34	70	455	3.82
ISAK-RG-1-8/190*	3.0	8	26	190	350	18	40	85	479	6.03
ISAK-RG-1-10/190*	5.0	10	32	190	350	22	50	115	519	10.02
ISAK-RG-1-13/190*	8.0	13	36	190	350	26	65	140	557	13.90
ISAK-RG-1-8/250*	3.0	8	36	250	460	18	40	85	589	12.86
ISAK-RG-1-10/250*	5.0	10	36	250	460	22	50	115	629	14.32
ISAK-RG-1-13/250*	8.0	13	36	250	460	26	65	140	667	16.33
ISAK-RG-1-16/250*	12.5	16	40	250	460	32	75	170	713	23.14

* Available on indent only.

2 Leg Slings – ISAK-RG-2



RUD Item #	WLL	Suit Chain	Dimensions (mm)							Weight
	t	mm	Ø A	B	C	Ø D	E	F	T	kg ea
ISAK-RG-2-6/140*	2.5	6	18	140	260	13	34	70	365	2.36
ISAK-RG-2-8/140*	4.25	8	22	140	260	18	40	85	389	4.03
ISAK-RG-2-10/140*	7.1	10	26	140	260	22	50	115	429	6.63
ISAK-RG-2-13/140*	11.2	13	32	140	260	26	65	140	467	10.47
ISAK-RG-2-6/190*	2.5	6	22	190	350	13	34	70	455	3.89
ISAK-RG-2-8/190*	4.25	8	26	190	350	18	40	85	479	6.13
ISAK-RG-2-10/190*	7.1	10	32	190	350	22	50	115	519	10.30
ISAK-RG-2-13/190*	11.2	13	36	190	350	26	65	140	557	14.93
ISAK-RG-2-8/250*	4.25	8	36	250	460	18	40	85	589	12.95
ISAK-RG-2-10/250*	7.1	10	36	250	460	22	50	115	629	14.61
ISAK-RG-2-13/250*	11.2	13	36	250	460	26	65	140	667	17.37
ISAK-RG-2-16/250*	17.0	16	40	250	460	32	75	170	713	25.16

* Available on indent only.



• All master links shown at this page are equipped with an allside flexible clevis connector which ensures fool-proof connection in regard to the chain diameter and number of legs. All master links include an identification tag with integrated chain gauge.



• Never exceed manufacturer's Working Load Limit (WLL).

MASTER LINKS WITH CONNECTOR FOR LARGE CRANE HOOKS

3 & 4 Leg Slings – ISAK-RG-4



RUD Item #	WLL	Suit Chain	Dimensions (mm)							Weight
	t	mm	Ø A	B	C	Ø D	E	F	T	kg ea
ISAK-RG-4-6/140*	3.75	6	22	140	260	13	34	70	365	3.24
ISAK-RG-4-8/140*	6.3	8	26	140	260	18	40	85	389	5.47
ISAK-RG-4-10/140*	10.6	10	32	140	260	22	50	115	429	9.70
ISAK-RG-4-6/190*	3.75	6	26	190	350	13	34	70	455	5.34
ISAK-RG-4-8/190*	6.3	8	32	190	350	18	40	85	479	9.14
ISAK-RG-4-10/190*	10.6	10	36	190	350	22	50	115	519	13.16
ISAK-RG-4-13/190*	17.0	13	40	190	350	26	65	140	557	19.14
ISAK-RG-4-8/250*	6.3	8	36	250	460	18	40	85	589	13.45
ISAK-RG-4-10/250*	10.6	10	36	250	460	22	50	115	629	15.60
ISAK-RG-4-13/250*	17.0	13	40	250	460	26	65	140	667	22.12
ISAK-RG-4-16/250*	26.5	16	47	250	460	32	75	170	713	32.98

* Available on indent only.

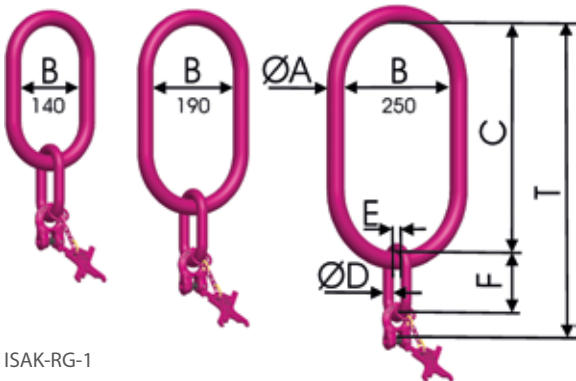

ISAK-RG-1

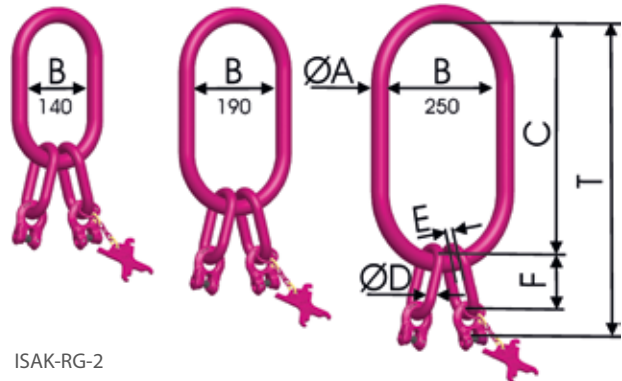

ISAK-RG-2

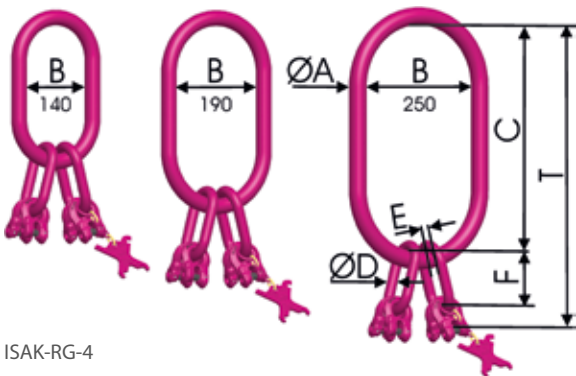

ISAK-RG-4

ISAK-RG Suitable Up To Crane Hook Size No.

RUD Item #	Size		
	B = 140	B = 190	B = 250
ISAK-RG	No. 16	No. 32	No. 50

- DIN15401



- All master links shown at this page are equipped with an allside flexible clevis connector which ensures fool-proof connection in regard to the chain diameter and number of legs. All master links include an identification tag with integrated chain gauge.



- Never exceed manufacturer's Working Load Limit (WLL).

GRADE 120

CONNECTORS

IVS Multi Purpose Connector



Product Code	RUD Item No.	WLL	Chain	Dimensions (mm)							Weight kg ea
		t	mm	A	B	C	D	E	F	T	
02398231	IVS-6	1.8	6	18	55	13.0	11	17	21.0	46	0.12
02398232	IVS-8	3.0	8	24	70	17.5	14	23	27.5	61	0.29
02398233	IVS-10	5.0	10	28	88	22.0	17	27	32.0	74	0.57
02398234*	IVS-13	8.0	13	34	111	28.0	23	33	40.0	93	1.20
02398235*	IVS-16	12.5	16	39	130	33.0	27	37	46.0	108	2.00

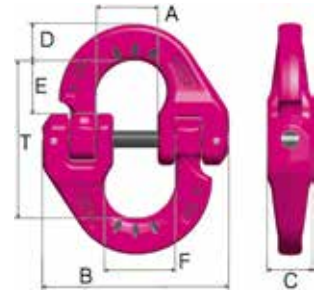

* Available on indent.

Lifting points, shackles and plate clamps can be attached into the halves of the connecting link. The halves are adjustable at will between each other.

- Form and function are patent pending.
- No kinking of pre-assembled chain possible.



IRG Clevis Connector



Product Code	RUD Item No.	WLL	Chain	Dimensions (mm)							Weight kg ea
		t	mm	A	B	C	D	E	F	T	
02398291*	IRG-6	1.8	6	19	34	44	21	9	12	36	0.12
02398292*	IRG-8	3.0	8	24	45	56	27	12	15	43	0.25
02398293*	IRG-10	5.0	10	30	56	70	32	15	19	53	0.5
02398294*	IRG-13	8.0	13	38	73	88	38	18	25	67	1.0
02398295*	IRG-16	12.5	16	47	90	109	48	23	31	83	2.0

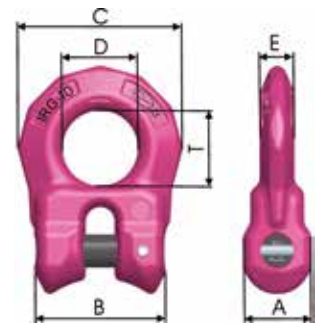

* Available on indent.

Designed for connection of non-RUD parts such as flanges, etc.

- Simple chain connection with ICE-oval G load pin and retaining pin supplied.



IH Compact Endless Sling Connector



Product Code	RUD Item No.	Suit Chain	Dimensions (mm)			Weight kg ea
		mm	A	B	T	
02398241	IH-6	6	34	19.6	18	0.11
02398242	IH-8	8	45	25.5	24	0.26
02398243	IH-10	10	56	31.5	30	0.55
02398244*	IH-13	13	73	40.0	39	1.16
02398245*	IH-16	16	89	49.0	48	2.16



* Available on indent.

Suitable for fabricating endless slings or repairing multi-leg chain. More compact and therefore easier to handle than conventional chain connectors.

- Fast, easy and economical fabricating of endless chains.
- Heat-treated body offers improved wear resistance.
- Enhanced slide cover corners.
- All RUD ICE-120 Connectors manufactured in Germany.



Endless Chain with H-Connector



• Never exceed manufacturer's Working Load Limit (WLL).

SLING CHAIN TENSIONERS

ICE-CURT-GAKO Ratchet Lifting Chain Tensioner



Product Code	RUD Item No.	WLL	Chain	Dimensions (mm)			Weight
		t	mm	L open	L closed	Reach	kg
02398251	ICE-CURT-6-GAKO	1.8	6	400	260	140	1.8
02398252	ICE-CURT-8-GAKO	3.0	8	520	350	170	3.2
02398253	ICE-CURT-10-GAKO	5.0	10	532	362	170	3.6
02398254*	ICE-CURT-13-GAKO	8.0	13	830	530	300	6.9
02398255*	ICE-CURT-16-GAKO	12.5	16	962	612	350	12.2

* Available on indent.

Allows precise adjustment of ICE-120 lifting sling chain.

- User friendly and space-saving tensioning lever.
- User friendly turn-loose securing when used with padlock such as ABUS 85/40 HB.
- 100% crack inspected, all load bearing parts drop forged.
- Easy to clean and lubricate, innovative forged design-light in weight and robust, Patent pending.
- User friendly – even with gloves.
- Manufactured in Germany.

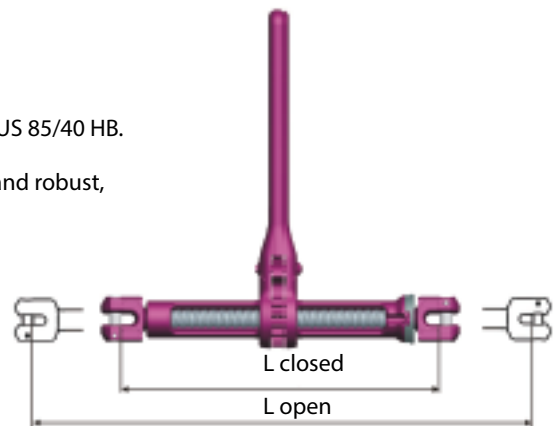

• Never exceed manufacturer's Working Load Limit (WLL).



• Adjustments must be made while sling is unloaded.

HOOKS

IAGH Clevis Self Locking Hook



Product Code	RUD Item No.	WLL	Suit Chain	Dimensions (mm)								Weight
		t	mm	A	B	C	D	F	F _{max}	G	T	kg
02398281	IAGH-6	1.8	6	34	24	27	28	97	44	60	113	0.9
02398282	IAGH-8	3.0	8	45	31	30	31	106	48	66	124	1.2
02398283	IAGH-10	5.0	10	50	38	36	40	136	61	81	154	2.4
02398284*	IAGH-13	8.0	13	73	50	44	51	173	78	107	200	4.9
02398285*	IAGH-16	12.5	16	90	61	49	53	192	85	121	232	7.4

* Available on indent.

Skeletal designed hook is up to 30% lighter than Grade 80 hooks of the same WLL. Large throat width has same dimensions as Grade 80 hook of the same WLL.

- Wear ribs protect the first link in the clevis.
- Thickened tip of hook to prevent incorrect and dangerous use.
- Locking device designed ergonomically, easy to handle with anti-skip surface – no danger of pinching fingers.
- Marker points to check the width of the hook on inspection.
- Manufactured in Germany.

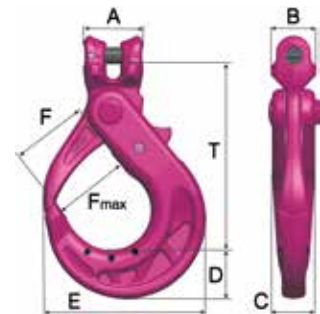

ISH Star Sling Hook



Product Code	RUD Item No.	WLL	Suit Chain	Dimensions (mm)								Weight
		t	mm	A	B	C	D	F	F _{max}	G	T	kg
02398271	ISH-6	1.8	6	48	28	18	26	30	51	97	97	0.69
02398272	ISH-8	3.0	8	45	36	20	29	36	58	112	110	1.1
02398273	ISH-10	5.0	10	71	43	25	37	41	66	135	127	1.9
02398274*	ISH-13	8.0	13	85	52	31	48	50	80	163	153	3.5
02398275*	ISH-16	12.5	16	94	58	38	56	58	96	196	184	5.5

* Available on indent.

The skeletal design ICE-SH Star Hook is up to 25% lighter than Grade 80 hooks of the same WLL, i.e. the next larger size. Patented wear marks that, without measuring, show instantly when the hook has reached the statutory allowable wear limit and must be replaced.

- Exceeds by far the EN standard values for side loading.
- Edge Protection: Increased section at the side and top of the hook for safety catch.
- Wear Ribs: Protect the first chain link into the clevis.
- No protruding hook tip.
- Manufactured in Germany.

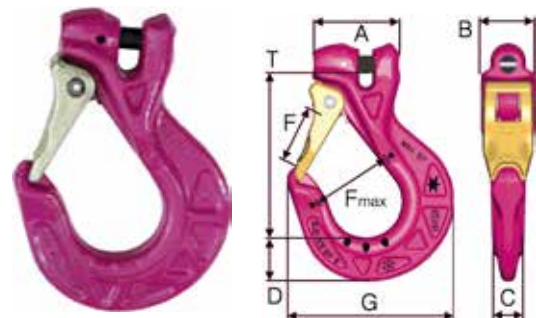

• Never exceed manufacturer's Working Load Limit (WLL).

HOOKS

IVH Grab Hook



Product Code	RUD Item No.	WLL	Suit Chain	Dimensions (mm)							Weight
		t	mm	A	B	C	D	E	F	T	kg
02398261	IVH-6	1.8	6	34	18	20	44	7.5	22	53	0.27
02398262	IVH-8	3.0	8	43	24	26	55	9.5	29	67	0.50
02398263	IVH-10	5.0	10	55	30	34	71	12.0	38	86	1.20
02398264*	IVH-13	8.0	13	70	38	43	90	15.0	48	105	2.50
02398265*	IVH-16	12.5	16	86	46	53	110	18.5	59	128	4.50

* Available on indent.

Due to offset lead-in groove chain remains in place even when untensioned.

- No reduction of ICE WLL when used as a shortening device.
- High dynamic strength.
- Enlarged tip of hook avoids incorrect use.
- Manufactured in Germany.



Examples –
IVH Application:

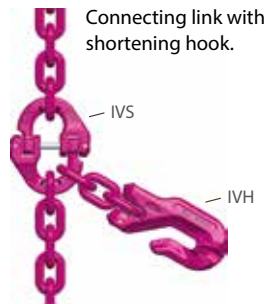

- Never exceed manufacturer's Working Load Limit (WLL).
- Where grab hooks are fitted as bottom hooks or chain is choked, the sling WLL must be derated by 20%.

TRIGGER KITS AND SAFETY LATCH KITS

Replacement IAGH Trigger Kits – Self Locking Hooks



Product Code	Size	Suit RUD Hook Product Code	Weight
			kg
02398281TK	6	02398281	0.03
02398282TK	8	02398282	0.04
02398283TK	10	02398283	0.06
02398284TK*	13	02398284	0.14
02398285TK*	16	02398285	0.20

* Available on indent.

Consist of a locking device, corrosion protected double-leg spring and retaining pin.

- Suit ICE-120 IAGH Self Locking Hooks.
- Easy assembly with hammer and punch.
- Manufactured in Germany.



Replacement ISH Latch Kits – Sling Hooks



Product Code	Size	Suit RUD Hook Product Code	Weight
			kg
02398271TK	6	02398271	0.09
02398272TK	8	02398272	0.11
02398273TK	10	02398273	0.15
02398274TK*	13	02398274	0.24
02398275TK*	16	02398275	0.40

* Available on indent.

Consists of a drop forged locking device, double coiled stainless steel spring, a retainer pin and mounting sleeve.

- Suit ICE-120 ISH Star Sling Hooks.
- Easy assembly with hammer and punch.
- Manufactured in Germany.



LOAD PIN KITS

ICE-120 Oval G Pin & Retaining Pin

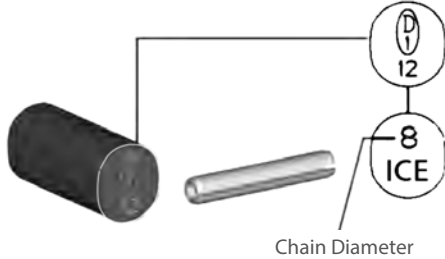

Product Code	RUD Item No.	Suit RUD Clevis Component Types	Size
			mm
02398221	I0G-6 / Retaining pin 6	IAK-RG, IBK-RG, ISAK-RG, IRG, IH, ICE-CURT GAKO, IAGH, ISH, IVH 	6
02398222	I0G-8 / Retaining pin 8		8
02398223	I0G-10 / Retaining pin 10		10
02398224*	I0G-13 / Retaining pin 13		13
02398225*	I0G-16 / Retaining pin 16		16

* Available on indent.

- Manufactured in Germany.



• Cookes recommends that Load Pins and Retaining Pins are replaced whenever clevis components are refitted.



• Only use genuine RUD-ICE Load Pins and Retaining Pins with ICE-120 components to maintain sling integrity.

GRADE 120





ICE-MINI MECANO SYSTEM



Introducing the smallest Grade 120 chain lifting system with 4mm diameter chain.

Working Load Limits (WLL) in Tonnes



ICEmini	Single Leg Slings	2 Leg		3 and 4 Leg (same ratings)	
					
Chain Ømm	Straight / Adj. Sling	0-90°	>90°-120°	0-90°	>90°-120°
4	0.80	1.12	0.80	1.7	1.18
Load Factor >	1	1.4	1	2.1	1.5

ICE-MINI 4mm Chain and Components

Product Code	RUD Item #	System ø	WLL	Inside Length	Inside Width	Weight
		mm	t	mm	mm	kg
02398204	ICE-Chain 4 x 12	4	0.8	12.0	5.2	0.44/m
02398170*	IAC 1/2	4	0.8/1.12	40.0	34.0	0.2/ea
02398180	IML-2	4	1.12	66.0	30.0	0.35/ea
02398190*	IML-4	4	1.70	60.0	35.0	0.85/ea
02398270	ISH-4	4	0.8	-	-	0.16/ea

* Available on indent from Australia.

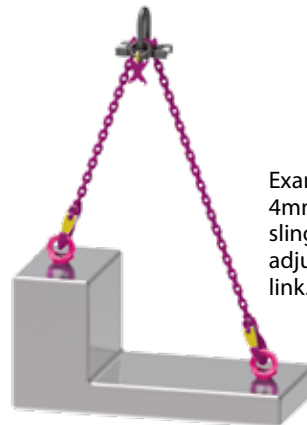

Example of 2 Leg 4mm grade 120 sling using IML-2 adjustable master link.



* The IML Series Master Links incorporate a button controlled shortening device allowing lightening fast leg length adjustment.

Super light weight chain lifting slings offering the ultimate in portability. Easily carried in tool kits or by hand.

- Complies with EN818 and EN1677.
- Manufactured in Germany.



• For larger crane hooks simply add the appropriate IAC-RG-1 Master Link (refer page 77).



• Never exceed manufacturer's Working Load Limit (WLL).

VIP MAXI-HEAVY LIFT

EXTRA HEAVY CHAIN LIFTING SET

VIP Grade 100 – 28mm Lifting Chain



Product Code	Size	WLL	Proof Load	Dimensions (mm)		Weight
	Ø D	t	kN	P	W1	kg / m
02398128*	28	31.5	772	84	36.4	18.6

* Available on indent.

- Minimum ultimate elongation of 20%.
- Stamped VIP on every link along with BG approval stamp H1.
- Duplex surface protection: pre-treatment plus pink powder coating.
- Manufactured in Germany.



VIP >20% lighter for same WLL!



VIP MAXI – 28mm
WLL 31.5t
VIP G100 – 28mm
1 Metre = 18.6kg



Grade 80 – 32mm
WLL 31.5t
Grade 80 – 32mm
1 Metre = 23.0kg

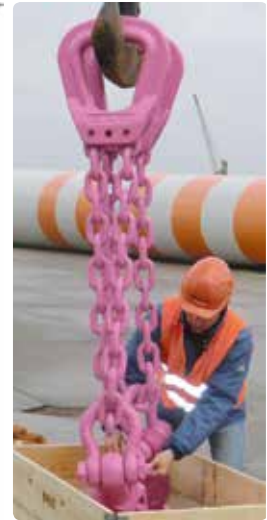

VIP MAXI 28mm WLL Chart – For Symmetrical Loads

Inclination Angle β	0°		0 – 45°	>45 – 60°	0 – 7°	>7 – 45°	0 – 45°
	WLL (t)	31.5	63.0	45.0	31.5	126	88
Load Factor	1	2	1.4	1	4	2.8	2.1

¹⁾ For unsymmetrical loads the WLL must be reduced by 50%.



RUD VIP Grade 100 MAXI Assembly Kits

- When the going gets tough RUD make it easy for you with their 28mm Grade 100 MAXI Chain Kits. Safe and secure lifting of heavy loads up to 126 tonne!







- Never exceed manufacturer's Working Load Limit (WLL).

VIP MAXI-HEAVY LIFT



EXTRA HEAVY CHAIN LIFTING SET

RUD VIP 28mm Grade 100 MAXI Assembly Kits are your ideal solution for heavy lifting with means to connect to wire rope or synthetic round slings. All items available on indent from RUDs Australian warehouse.





Connection Possibilities







Sling Variants

End Fittings

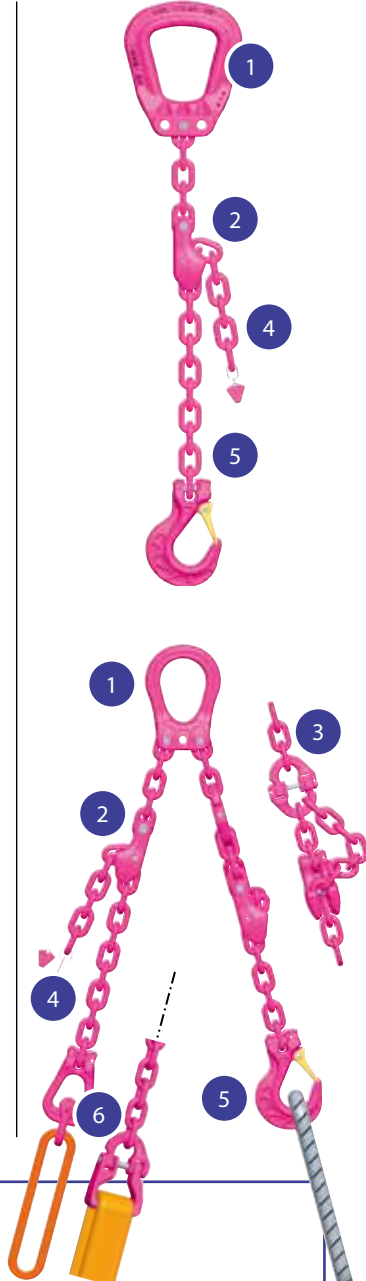

i

1. VIP >MAXI< Masterlinks 1/2-28 and VBK 1/2-28, for 1 and 2-leg slings.
2. VIP >MAXI< Shortening claw VV28 to secure against self-acting loosening.
3. VIP >MAXI< Connecting link for connection to lifting points, shackles, chain etc.
4. VIP >MAXI< Round steel link chain 28 x 84, quality grade 10, extremely robust and wear resistant, pink powder coated.
5. VIP >MAXI< VCGH-28, proven and tested Cobra-clevis hook in skeletal light weight-design with a robust, forged safety latch.
6. VIP >MAXI< End link VB-28, for chain coupler or shackle connection.



• Never exceed manufacturer's Working Load Limit (WLL).

CARE & USE VIP MAXI & ICE-120

Care

- Store Chain Slings on A frames or wall racks in a clean dry place.
- Keep a record of all chain slings in use.
- Lightly oil chains before prolonged storage.
- Never weld or heat treat alloy chain slings.



Use – Pre Lifting Checks

- Always visually inspect that a chain sling is free from damage or wear before use.

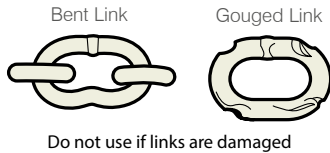

- Never load in excess of the Safe Working Load for the application
- If identification tag is lost, damaged or un-readable, then chains should be removed from service and referred to a competent person for inspection.
- A chain sling must not be used without a tag that can be cross-referenced to supply certification.
- Ensure the weight of the load is known and evenly distributed when using multi leg slings.
- Shorten chain legs with shortening hooks or clutches only.
- Ensure the chain is free of twists before lifting and is protected from any sharp corners on the load.
- Never tie a knot in the chain.

Use – During Lifting

- Avoid shock loading – commence the lift slowly. Take up the weight gradually by avoiding sharp movements.
- When lowering, avoid the possibility of crushing the chain by ensuring the load does not land on it. Use sufficient packaging and timber, etc.

Inspection and Maintenance

- Periodic examination is required at least every 6 months.
- Clean the chain thoroughly.
- Every chain sling should have an identification tag which states the Safe Working Load (SWL) or Working Load Limit (WLL) of the sling.
- Lay the chain on a clean surface or hang it up in a well lit area.
- Every chain link should be individually inspected for any signs of wear, twisting, stretching, nicks, gouging and any worn link measured to determine the degree of wear using vernier calipers. 10% maximum loss of cross section is permissible.
- Accessories – Lifting hooks must be replaced when:
 - the opening of the mouth is deformed more than 10%, or
 - if hook is worn more than 5%, or
 - shows signs of deep notches
- Chain couplings should be inspected for signs of wear or heat at the loading points, for excessive play in the pins and for impaired rotation of the body halves around the load pin.
- Chain links or fittings having any defects should be clearly marked to indicate rejection and the chain sling withdrawn from service and assessed by a competent person.



• For a more detailed inspection please contact Cookes, your New Zealand authorised distributor for RUD.

CARE & USE VIP MAXI & ICE-120

RUD VIP chain

The special VIP pink powder coating changes its colour with temperatures exceeding 200°C. Chains should not be used after being subjected to temperatures exceeding 400°C. At this temperature, the VIP changes colour to a deep black with small bubbles indicating that it has been overheated.



RUD ICE-120 chain







The special ICE purple powder coating changes its colour with temperatures exceeding 200°C. It is prohibited to use ICE chain in temperatures of more than 300°C. This is clearly displayed by ICE purple colour turning brown-black.

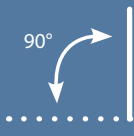

 • For a more detailed inspection please contact Cookes, your New Zealand authorised distributor for RUD.

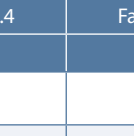
CHAIN SLING WORKING LOAD LIMITS

The Uniform Method for Rating Stainless Steel Chain Slings

Lifting Mode	1 Leg	2 Leg		3 & 4 Leg – Same Ratings		Endless Sling
						
Chain Ø	Factor 1.0	Factor 1.4	Factor 1.0	Factor 2.1	Factor 1.5	Factor 1.6
mm	90°	90°	120°	90°	120°	
6.00	0.70	1.00	0.70	1.47	1.05	1.12
8.00	1.20	1.70	1.20	2.50	1.80	1.92
10.00	1.60	2.25	1.60	3.36	2.40	2.56
13.00	2.70	3.80	2.70	5.70	4.05	4.32

WORKING LOAD LIMITS IN TONNES FOR STAINLESS STEEL CHAIN SLINGS

The Working Load Limits (WLL) listed in the table above are the maximum weights which slings are designed to sustain in General Lifting Service according to the standard uniform load method of rating.

General Purpose Chain Slings must always be rated by the Uniform Method. Under this method, four-leg chain slings have the same WLL rating as three-leg slings based on an assumption that at least one leg of a four-leg sling may not be accepting its full share of the load.

In exceptionally hazardous conditions or in any other circumstances which might indicate a need for WLL lower than the designated figure, the degree of hazard should be assessed by a competent person and a Safe Working Load (SWL) determined.

Note: When slings are used in a choke hitch or grab hooks fitted as bottom hooks, the WLL must be reduced by 20%.



- Never exceed manufacturer's Working Load Limit (WLL).
- Never use stainless steel chain and components for lifting unless you have tagged and certified sling assemblies from a reputable supplier.

GRADE 50 STAINLESS STEEL

CHAIN & CONNECTORS

Stainless Steel Lifting Chain



Product Code	Excel Item No.	WLL	Dimensions (mm)			Links	Weight
		t	Ø a	b	c	per Meter	per Meter
02479006	CHAIN6I	0.7	6	18	21	55.56	0.78
02479008	CHAIN8I	1.2	8	24	29	41.67	1.30
02479010	CHAIN10I	1.6	10	30	34	33.33	2.14
02479013	CHAIN13I	2.7	13	39	45	25.64	3.64

Stainless Steel Lifting Chain.

- Polished finish.
- AISI316L material.
- Tested and certified.
- 4:1 design factor.
- Manufactured in France.

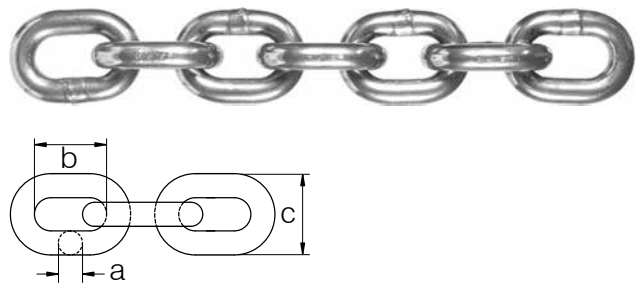

Stainless Steel Connecting Links



Product Code	Excel Item No.	WLL	For Chain	Dimensions (mm)							Weight
		t	Ømm	Ø a	b	c	d	e	f	g	kg
02481106	MJ6I	0.7	6	8	43	11	14	45	11	16	0.10
02481108	MJ7/8I	1.2	7-8	9	52	14	18	55	14	20	0.16
02481110	MJ10I	1.6	10	13	70	16	25	73	18	25	0.36
02481113	MJ13I	2.7	13	18	85	19	32	92	25	28	0.73

Stainless Steel Connectors.

- Polished finish.
- AISI316L material.
- Tested and certified.
- 4:1 design factor.
- Manufactured in France.

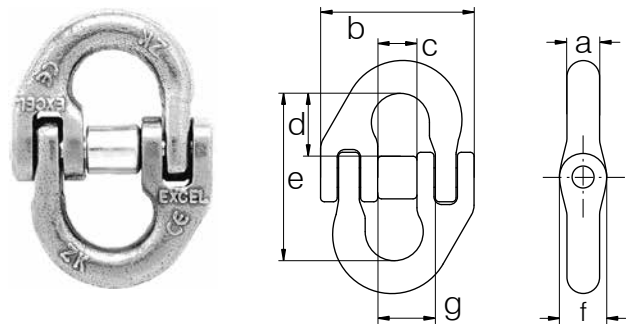

• Never exceed manufacturer's Working Load Limit (WLL).

GRADE 50 STAINLESS STEEL

MASTER LINKS & MULTI OBLONG LINKS

Stainless Steel Master Links for 1 & 2 Leg Slings

EXCEL®

Product Code	Excel Item No.	WLL	Ø 1 Leg	Ø Chain 2 Legs (mm)		Dimensions (mm)				Weight
		t	mm	$\beta \leq 45^\circ$	$\beta \leq 60^\circ$	a	b	c	d	kg
02480006	MS13I	0.75	6	—	6	13	110	60	6	0.34
02480008	MS16I	1.25	8	6	8	16	110	60	6	0.53
02480010	MS18I	2.00	10	8	10	18	135	75	8	0.82
02480013	MS22I	3.20	13	10	13	22	160	90	10	1.45
02480016	MS26I	5.00	16	13	16	26	180	100	14	2.29

Stainless Steel Master Links.

- Polished finish.
- AISI316L material.
- Tested and certified.
- 4:1 design factor.
- Manufactured in France.

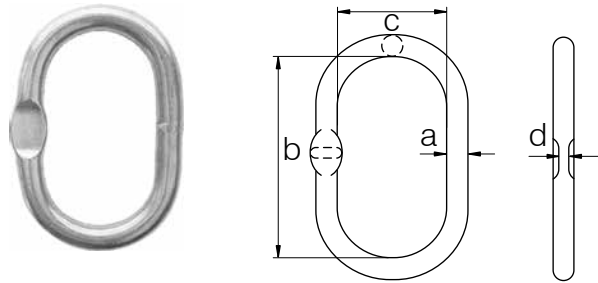

Stainless Steel Multi Oblong Links for 3 & 4 Leg Slings

EXCEL®

Product Code	Excel Item No.	WLL	3/4 Legs	Dimensions (mm)							Weight
		t	Ømm	Ø a	b	c	d	e	f	g	kg
02480106	MTS18I	1.60	6	18	135	75	13	54	25	6	1.17
02480108	MTS22I	2.65	8	22	160	90	16	70	34	8	2.17
02480110	MTS26I	4.25	10	26	180	100	18	85	40	8	3.34
02480113	MTS32I	6.70	13	32	200	110	22	115	50	13	5.99

Stainless Steel Multi Oblong Links.

- Polished finish.
- AISI316L material.
- Tested and certified.
- 4:1 design factor.
- Manufactured in France.

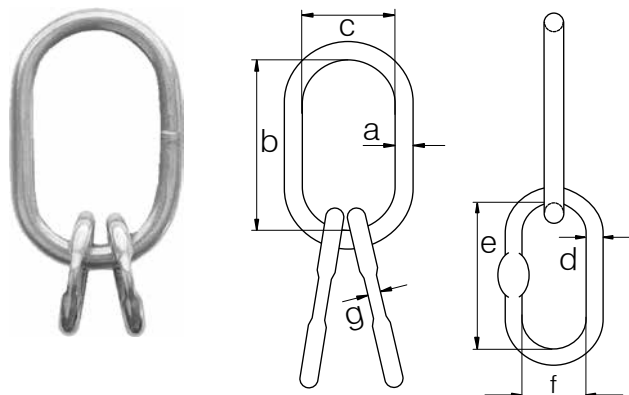

• Never exceed manufacturer's Working Load Limit (WLL).

GRADE 50 STAINLESS STEEL

HOOKS

Stainless Steel Clevis Sling Hooks



Product Code	Excel Item No.	WLL	For Chain	Dimensions (mm)									Weight
		t	Ømm	a	b	c	d	e	f	g	h	Ø i	kg
02483006	CSC6I	0.7	6	76	7	25	15	19	27	73	108	8	0.29
02483008	CSC7/8I	1.2	8	95	9	28	20	22	32	85	133	9	0.55
02483010	CSC10I	1.6	10	113	11	28	24	28	41	106	164	13	0.97
02483013	CSC13I	2.7	13	138	15	38	32	40	52	133	208	16	1.86

Stainless Steel Clevis Sling Hook c/w Safety Catch.

- Polished finish.
- AISI316L material.
- Tested and certified.
- 4:1 design factor.
- Manufactured in France.

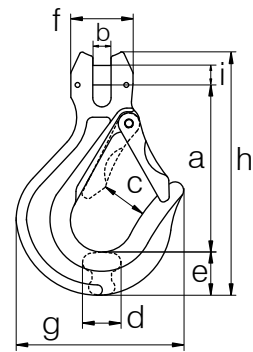

Stainless Steel Eye Sling Hooks



Product Code	Excel Item No.	WLL	For Chain	Dimensions (mm)										Weight
		t	Ømm	a	Ø b	c	d	e	Ø f	g	h	i	j	kg
02483106	CSO6I	0.7	6	86	23	27	15	19	43	73	115	10	7	0.28
02483108	CSO7/8I	1.2	8	102	26	27	19	23	51	87	137	13	8	0.56
02483110	CSO10I	1.6	10	121	35	28	23	29	66	106	165	15	11	1.02
02483113	CSO13I	2.7	13	155	41	33	31	36	76	136	208	19	14	1.77

Stainless Steel Eye Type Sling Hooks c/w Safety Catch.

- Polished finish.
- AISI316L material.
- Tested and certified.
- 4:1 design factor.
- Manufactured in France.

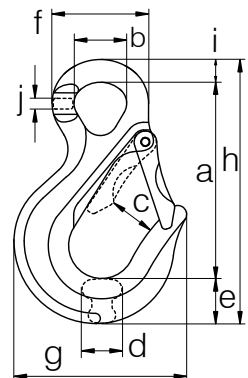

• Never exceed manufacturer's Working Load Limit (WLL).

HOOKS

Stainless Steel Eye Grab Hooks

EXCEL[®]

Product Code	Excel Item No.	WLL	For Chain	Dimensions (mm)									Weight
		t	Ømm	a	b	c	d	e	f	g	h	i	kg
02483208	CRO7/8I	1.2	7 – 8	52	20	20	10	33	23	46	108	8	0.32
02483210	CRO10I	1.6	10	53	29	29	12	41	28	58	123	10	0.53
02483213	CRO13I	2.7	13	89	43	39	15	56	40	78	192	18	1.64

Stainless Steel Eye Grab Hook. No reduction in WLL when used as a shortening hook.

- Polished finish.
- AISI316L material.
- Tested and certified.
- 4:1 design factor.
- Manufactured in France.

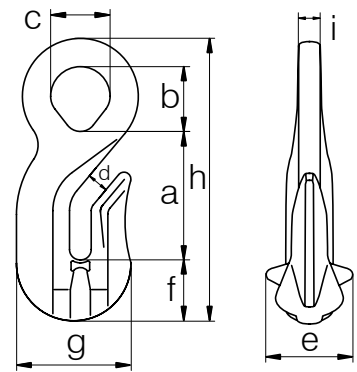

- Never exceed manufacturer's Working Load Limit (WLL).
- Note: Where grab hooks are fitted as bottom hooks or chain is choked, the sling WLL must be derated by 20%.

GRADE 50 STAINLESS STEEL

CARE & USE G50 CHAIN SLINGS

All stainless steel items should be inspected before use to ensure that:

- all markings are legible
- all items are free from nicks, gouges and cracks
- items with the correct Working Load Limit have been selected with respect to the sling design i.e. the load to be lifted, the number of legs in the sling, the top angle etc. For further details, refer to the general instructions for care and use of chain slings following the Grade 100 section
- items may not be heat treated as this may affect their Working Load Limit
- never modify, repair or reshape an item by machining, welding, heating or bending as this may affect the WLL
- master links and the other items of the sling are all identifiable as being in stainless steel and for lifting purposes
- items are not distorted or unduly worn.

Inspection is required because the products in use may be affected by wear, misuse, overloading, etc. causing deformation and alteration of the material structure.

Corrosion Resistance Table for Stainless Steel AISI 316

Substance	Resistance	Substance	Resistance
Acetic Acid <20%	S	Hydrogen Cyanide 100%	L
Ammonia (100%)	S	Hydrogen Peroxide <35%	S
Ammonium Chloride <1%	S	Hydrogen Sulphide 100%	S
Ammonium Nitrate 10% – 50%	S	Mineral Oil	S
Ammonium Sulphate <10%	L	Nitric Acid <10%	S
Benzene	S	Potassium Sulphate <10%	S
Calcium Hypochlorite (100%)	U	Sodium Chloride <5%	S
Citric Acid <10%	S	Sodium Hypochlorite <20%	L
Copper Sulphate <10%	S	Sodium Nitrate 10% – 40%	S
Ethanol	S	Sodium Sulphate <10%	S
Gasoline	S	Zinc Chloride <10%	S
Hydrochloric Acid (all concentrations)	U	Zinc Sulphate <10%	S

The corrosion resistance table for stainless steel is provided as a guide only and should not be considered as a substitute for testing under specific conditions.

Abbreviations

- S = Satisfactory: no or very little corrosion.
- L = Limited resistance: exposure time must be limited, some corrosion might occur.
- U = Unsatisfactory: not suitable for use.



- Inspection by a competent person should take place at least every six months and more frequently when the components are used in severe operating conditions.
- Please note that the general care and use instructions covering grade 80 and grade 100 chain slings also apply to grade 50 Stainless Steel Chain Slings.

COOKES

a BRIDON · BEKAERT Ropes Group Brand

Customerservices@cookes.co.nz

www.cookes.co.nz



facebook.com/BridonBekaert



linkedin.com/company/bridon-bekaert



twitter.com/bridonbekaert

Head Office

Bridon New Zealand Limited
trading as **Cookes**

6-10 Greenmount Drive, East Tamaki

PO Box 14 422, Panmure

Auckland

0508 274 366

+64 9 274 4299

Disclaimer:

Whilst every effort has been made to ensure the accuracy of information in this publication, no guarantee or warranty (expressed or implied) is given with respect to the accuracy or completeness of the information contained within. This publication and the products described herein may be changed or updated without notice. Any and all liability whatsoever for any loss or damage arising, directly or indirectly, out of or in connection with the use of this publication, is excluded to the fullest extent permitted by law. The user must determine the suitability of the product for their own particular purpose, either alone or in combination with other products and shall assume all risk and liability in connection therewith. This document is published by Bridon New Zealand Ltd. Use of this publication shall be governed in accordance with the laws of New Zealand courts and shall have exclusive jurisdiction over any dispute concerning your use of this publication.

Intellectual Property:

All rights reserved. No parts of this publication may be reproduced or transmitted in any form or by any means without the prior written permission of the copyright holder, application for which should be addressed to Bridon New Zealand Ltd.

Edition 01/2018 Cookes Lifting Chains & Components Brochure

BRIDON · BEKAERT
THE ROPES GROUP